

Fabricamos para ti

*La vida es como andar en bicicleta,
para conservar el equilibrio
debes mantenerte en movimiento.*

Albert Einstein

*Sólo la experiencia adquirida duran-
te estos 38 años, nos ha proporci-
onado las herramientas necesarias
para conseguir posicionar nuestra
empresa como marca
de referencia en el mercado.*

*En nuestras instalaciones
de 6.500 m², se fabrican
íntegramente cada uno de nuestros
modelos, consiguiendo así poder
supervisar todos los procesos de
trabajo a través de nuestro
departamento de calidad.*

*Sólo seleccionando las mejores
materias primas de proveedores
nacionales y a través de la espe-
cialización de nuestro personal con
dos líneas de producción separadas
(metal y madera), se consigue un
alto nivel de satisfacción de nues-
tros clientes que año tras año han
confiado en nosotros.*

English

*Life is like riding a bicycle.
To keep your balance
you must keep moving.*

Albert Einstein

*Only the experience gained during
these 38 years has provided us the
tools to get position our company as a
leading brand in the market tools.*

*At our facilities 6,500 m², is entirely
made each of our models and getting
to monitor all work processes through
our quality department.*

*Selecting only the best raw materials
from domestic suppliers and through
the expertise of our staff with two
separate production lines (metal and
wood), a high level of customer satis-
faction that is achieved year after year
have trusted us.*

Français

*La vie est comme faire du vélo.
pour garder votre équilibre,
vous devez continuer à avancer.*

Albert Einstein

*Nos 38 années d'expérience nous ont
fournis le nécessaire pour positionner notre
entreprise comme un référentiel de notre
secteur sur le marché.*

*La totale fabrication de chacun de nos mo-
dèles dans nos installations de 6.500 m²,
permet que notre département de qualité
puisse contrôler entièrement le processus
de fabrication.*

*La sélection des meilleures matières pre-
mières de nos fournisseurs nationaux, et
la spécialisation de notre personnel avec
deux lignes de fabrication (métal et bois),
nous permet d'obtenir une grande satisfac-
tion de nos clients qui nous font confiance
depuis des années.*



Tivoli

Chaiselongue

Tapizados disponibles
serie H y M



Tivoli

Tapizados disponibles
serie H y M

Chaiselongue

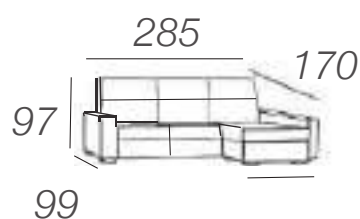

Ancho: 285 CM
Fondo chaise: 170 CM
Alto: 97 CM
Fondo: 99 CM



CABEZALES RECLINABLES

ASIENTOS DESLIZANTES

ARCÓN



Estructura de madera forrada en napa y goma.

Wooden frame covered with imitation leather and foam.
Structure en bois recouvert en napée et mousse.



Respaldos reclinables con fibra hueca y goma picada.

Reclining backrest with hollow fibre and chopped foam.
Dossier inclinable garni de fibre creuse et piquage de mousse.



Asiento extraíble regulable.

Adjustable pull-out seat.
Siège coulissant réglable.



Brazos, asientos y respaldos desenfundables.

Removable covers on armrest, seats and backrest.
Acoudoirs, sièges et dossiers déhoussables.



Espuma de poliuretano de alta densidad HR más fibra.

30 kg high-density polyurethane foam HR plus fiber.
Mousse polyuréthane haute densité 30 kg/m³. HR + fibres.



Fibra hueca de alta calidad siliconada.

High quality silicone hollow fibre.
Fibres creuses en silicone de haute qualité.



Patas de metal.

Metal legs.
Pieds en metal.



Materiales de primera calidad.

Premium quality materials.
Materiaux de première qualité.



Fabricado con materiales reciclables.

Manufactured with recyclable materials.
Fabriqué en matériaux recyclable.

Botonía

Chaiselongue

Tapizados disponibles
serie H y M



Botonia

Chaiselongue

Tapizados disponibles
serie H y M

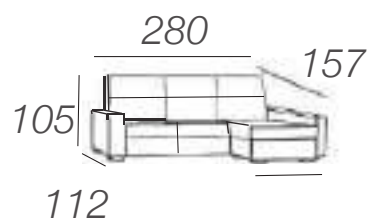

Ancho: 280 CM
Fondo chaise: 157 CM
Alto: 105 CM
Fondo: 112 CM



CABEZALES RECLINABLES SISTEMA ITALIANO
ASIENTOS DESLIZANTES
ARCÓN



Estructura de madera forrada en napa y goma.

Wooden frame covered with imitation leather and foam.
Structure en bois recouvert en nappée et mousse.



Respaldos reclinables con fibra hueca y goma picada.

Reclining backrest with hollow fibre and chopped foam.
Dossier inclinable garni de fibre creuse et piquage de mousse.



Asiento extraíble regulable.

Adjustable pull-out seat.
Siège coulissant réglable.



Brazos, asientos y respaldos desenfundables.

Removable covers on armrest, seats and backrest.
Acoudoirs, sièges et dossiers déhoussables.



Espuma de poliuretano de alta densidad HR 28 kg/m³ más fibra.

28 kg high-density polyurethane foam HR plus fiber.
Mousse polyuréthane haute densité 28 kg/m³. HR + fibres.



Fibra hueca de alta calidad siliconada.

High quality silicone hollow fibre.
Fibres creuses en silicone de haute qualité.



Patas de metal.

Metal legs.
Pieds en metal.



Materiales de primera calidad.

Premium quality materials.
Materiaux de première qualité.



Fabricado con materiales reciclables.

Manufactured with recyclable materials.
Fabriqué en matériaux recyclable.

Boston

Chaiselongue

Tapizados disponibles
serie H y M



Boston

Tapizados disponibles
serie H y M

Chaiselongue

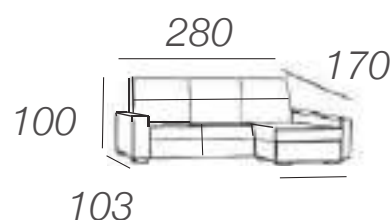

Ancho: 280 CM
Fondo chaise: 170 CM
Alto: 100 CM
Fondo: 103 CM



CABEZALES RECLINABLES

ASIENTOS DESLIZANTES



Estructura de madera forrada en napa y goma.

Wooden frame covered with imitation leather and foam.
Structure en bois recouvert en napée et mousse.



Respaldos reclinables con fibra hueca y goma picada.

Reclining backrest with hollow fibre and chopped foam.
Dossier inclinable garni de fibre creuse et piquage de mousse.



Asiento extraíble regulable.

Adjustable pull-out seat.
Siège coulissant réglable.



Patas de metal.

Metal legs.
Pieds en metal.



Brazos, asientos y respaldos desenfundables.

Removable covers on armrest, seats and backrest.
Acoudoirs, sièges et dossiers déhoussables.



Espuma de poliuretano de alta densidad HR 30 kg/m³ más fibra.

30 kg/m³ high-density polyurethane foam HR plus fiber.
Mousse polyuréthane haute densité 30 kg/m³. HR + fibres.



Fibra hueca de alta calidad siliconada.

High quality silicone hollow fibre.
Fibres creuses en silicone de haute qualité.



Materiales de primera calidad.

Premium quality materials.
Materiaux de première qualité.



Fabricado con materiales reciclables.

Manufactured with recyclable materials.
Fabriqué en matériaux recyclable.



4 cm de visco elástica en los asientos.

Seats with 4 cm memory foam.
4 cm viscoélastique en sièges.



Ideal para robot aspirador.

Ideal for vacuum robot.
Idéal pour le aspirateur robot.

Noa

Chaiselongue

Tapizados disponibles
serie H y M



Noa

Chaiselongue

Tapizados disponibles
serie H y M

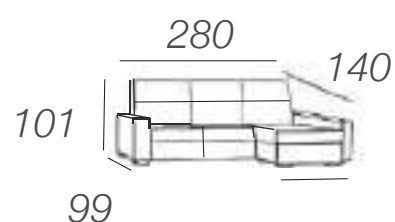

Ancho: 280 CM
Fondo chaise: 140 CM
Alto: 101 CM
Fondo: 99 CM



MEDIDA CAMA ABIERTA INTERIOR 90x217 cm

CABEZALES RECLINABLES

ASIENTOS DESLIZANTES LARGOS

ARCÓN

CHAISELONGUE REVERSIBLE



Estructura de madera forrada en napa y goma.

Wooden frame covered with imitation leather and foam.
Structure en bois recouvert en napée et mousse.



Respaldos reclinables con fibra hueca y goma picada.

Reclining backrest with hollow fibre and chopped foam.
Dossier inclinable garni de fibre creuse et piquage de mousse.



Asiento extraíble regulable.

Adjustable pull-out seat.
Siège coulissant réglable.



Brazos, asientos y respaldos desfundables.

Removable covers on armrest, seats and backrest.
Acoudoirs, sièges et dossiers déhoussables.



Espuma de poliuretano de alta densidad HR 28kg/m³ más fibra.

28 kg high-density polyurethane foam HR plus fiber.
Mousse polyuréthane haute densité 28 kg/m³. HR + fibres.



Fibra hueca de alta calidad siliconada.

High quality silicone hollow fibre.
Fibres creuses en silicone de haute qualité.



Patas de metal.

Metal legs.
Pieds en metal.



Materiales de primera calidad.

Premium quality materials.
Materiaux de première qualité.



Fabricado con materiales reciclables.

Manufactured with recyclable materials.
Fabriqué en matériaux recyclable.

Noa

Sofá 3p deslizable

Tapizados disponibles
serie H y M



Noa

Sofá 3p deslizante

Tapizados disponibles
serie H y M

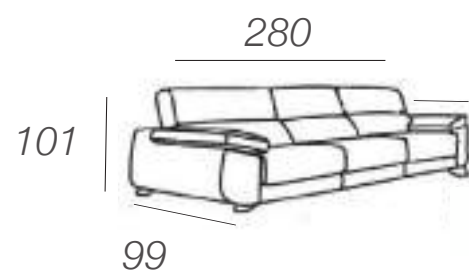

Ancho: 280 CM
Alto: 101 CM
Fondo: 99 CM



CABEZALES RECLINABLES

ASIENTOS DESLIZANTES LARGOS

MEDIDA CAMA ABIERTA INTERIOR 90x217 cm



Estructura de madera forrada en napa y goma.

Wooden frame covered with imitation leather and foam.
Structure en bois recouvert en napée et mousse.



Respaldos reclinables con fibra hueca y goma picada.

Reclining backrest with hollow fibre and chopped foam.
Dossier inclinable garni de fibre creuse et piquage de mousse.



Asiento extraíble regulable.

Adjustable pull-out seat.
Siège coulissant réglable.



Brazos, asientos y respaldos desfundables.

Removable covers on armrest, seats and backrest.
Acoudoirs, sièges et dossiers déhoussables.



Espuma de poliuretano de alta densidad HR 28kg/m³ más fibra.

28 kg high-density polyurethane foam HR plus fiber.
Mousse polyuréthane haute densité 28 kg/m³. HR + fibres.



Fibra hueca de alta calidad siliconada.

High quality silicone hollow fibre.
Fibres creuses en silicone de haute qualité.



Patas de metal.

Metal legs.
Pieds en metal.



Materiales de primera calidad.

Premium quality materials.
Materiaux de première qualité.



Fabricado con materiales reciclables.

Manufactured with recyclable materials.
Fabriqué en matériaux recyclable.

Sofía

Chaiselongue

Tapizados disponibles
serie H y M



Sofía

Chaiselongue

Tapizados disponibles
serie H y M

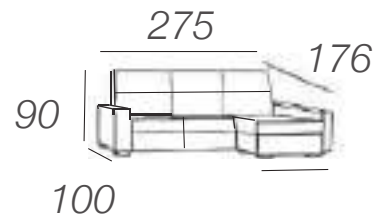

Ancho: 275 CM
Fondo chaise: 176 CM
Alto: 90 CM
Fondo: 100 CM



Estructura de madera forrada en napa y goma.

Wooden frame covered with imitation leather and foam.
Structure en bois recouvert en nappée et mousse.



4 cm de visco elástica en los asientos.

Seats with 4 cm memory foam.
4 cm viscoelastique en sièges.



Cojines decorativos, asientos y respaldos desenfundables.

Removable covers on decorative pillows, seats and backrest.
Coussins décoratifs, sièges et dossiers déhoussables.



Espuma de poliuretano de alta densidad HR 30 kg/m³ más fibra.

30 kg/m³ high-density polyurethane foam HR plus fiber.
Mousse polyuréthane haute densité 30 kg/m³. HR + fibres.



Fibra hueca de alta calidad siliconada.

High quality silicone hollow fiber.
Fibres creuses en silicone de haute qualité.



Patas de madera.

Wooden legs.
Pieds en bois.



Materiales de primera calidad.

Premium quality materials.
Matériaux de première qualité.



Fabricado con materiales reciclables.

Manufactured with recyclable materials.
Fabriqué en matériaux recyclable.



Ideal para robot aspirador.

Ideal for vacuum robot.
Idéal pour le aspirateur robot.

Sofía

Sofá 3+2 plazas

Tapizados disponibles
serie H y M



Sofía

Sofá 3+2 plazas

Tapizados disponibles
serie H y M



3 PLAZAS

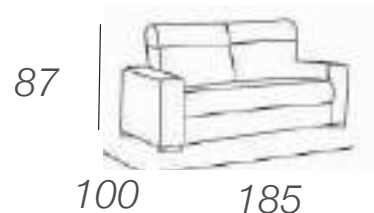

2 PLAZAS

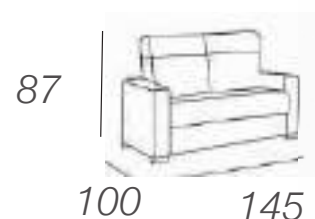

Ancho: 185 CM
Fondo: 100 CM
Alto: 87 CM

Ancho: 145 CM
Fondo: 100 CM
Alto: 87 CM



Estructura de madera forrada en napa y goma.

Wooden frame covered with imitation leather and foam.
Structure en bois recouvert en nappée et mousse.



Cojines, asientos y respaldos desenfundables.

Removable covers on decorative, seats and backrest.
Coussins, sièges et dossiers déhoussables.



Espuma de poliuretano de alta densidad HR 28 kg/m³ más fibra.

28 kg/m³ high-density polyurethane foam HR plus fiber.
Mousse polyuréthane haute densité 28 kg/m³. HR + fibres.



Fibra hueca de alta calidad siliconada.

High quality silicone hollow fiber.
Fibres creuses en silicone de haute qualité.



Patas de madera.

Wooden legs.
Pieds en bois.



Materiales de primera calidad.

Premium quality materials.
Matériaux de première qualité.



Fabricado con materiales reciclables.

Manufactured with recyclable materials.
Fabriqué en matériaux recyclables.



Ideal para robot aspirador.

Ideal for vacuum robot.
Idéal pour le aspirateur robot.

Nadot

Sofá 2 y 3 plazas

Tapizados disponibles
serie H y M



Nadot

Sofá



3 PLAZAS

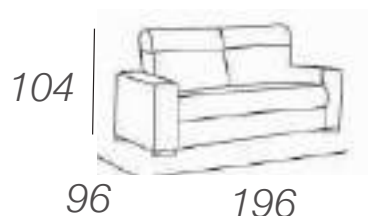

2 PLAZAS

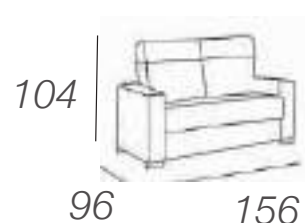

Ancho: 196 CM
Fondo: 96 CM
Alto: 104 CM

Ancho: 156 CM
Fondo: 96 CM
Alto: 104 CM

ASIENTOS DESLIZANTES



Estructura de madera forrada en napa y goma.

Wooden frame covered with imitation leather and foam.
Structure en bois recouvert en nappée et mousse.



Asiento extraíble regulable.

Adjustable pull-out seat.
Siège coulissant réglable.



Brazos, asientos y respaldos desenfundables.

Removable covers on armrest, seats and backrest.
Acoudoirs, sièges et dossiers déhoussables.



Espuma de poliuretano de alta densidad HR 28 kg/m³ más fibra.

28 kg/m³ high-density polyurethane foam HR plus fiber.
Mousse polyuréthane haute densité 28 kg/m³. HR + fibres.



Fibra hueca de alta calidad siliconada.

High quality silicone hollow fiber.
Fibres creuses en silicone de haute qualité.



Patas de metal.

Metal legs.
Pieds en metal.



Materiales de primera calidad.

Premium quality materials.
Matériaux de première qualité.



Fabricado con materiales reciclables.

Manufactured with recyclable materials.
Fabriqué en matériaux recyclable.



Ideal para robot aspirador.

Ideal for vacuum robot.
Idéal pour le aspirateur robot.

Lyon

Chaiselongue

Tapizados disponibles
serie H y M



Lyon

Chaiselongue

Tapizados disponibles
serie H y M

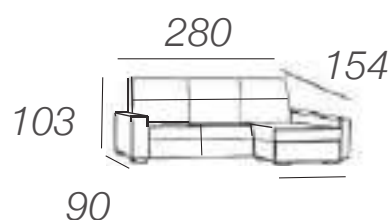

Ancho: 280 CM
Fondo chaise: 154 CM
Alto: 103 CM
Fondo: 90 CM



CABEZALES RECLINABLES

ASIENTOS DESLIZANTES

ARCÓN



Estructura de madera forrada en napa y goma.

Wooden frame covered with imitation leather and foam.
Structure en bois recouvert en napée et mousse.



Respaldos reclinables con fibra hueca y goma picada.

Reclining backrest with hollow fibre and chopped foam.
Dossier inclinable garni de fibre creuse et piquage de mousse.



Asiento extraíble regulable.

Adjustable pull-out seat.
Siège coulissant réglable.



Brazos, asientos y respaldos desenfundables.

Removable covers on armrest, seats and backrest.
Acoudoirs, sièges et dossiers déhoussables.



Espuma de poliuretano de alta densidad HR 28kg/m³ más fibra.

28 kg high-density polyurethane foam HR plus fiber.
Mousse polyuréthane haute densité 28 kg/m³, HR + fibres.



Fibra hueca de alta calidad siliconada.

High quality silicone hollow fibre.
Fibres creuses en silicone de haute qualité.



Patas de metal.

Metal legs.
Pieds en metal.



Materiales de primera calidad.

Premium quality materials.
Materiaux de première qualité.



Fabricado con materiales reciclables.

Manufactured with recyclable materials.
Fabriqué en matériaux recyclable.

Lyon

Sofá 2 y 3 plazas

Tapizados disponibles
serie H y M



Lyon

Sofá

Tapizados disponibles
serie H y M

3 PLAZAS

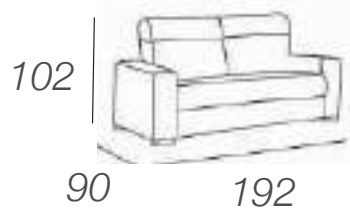

Ancho: 192 CM
Fondo: 90 CM
Alto: 102 CM

2 PLAZAS

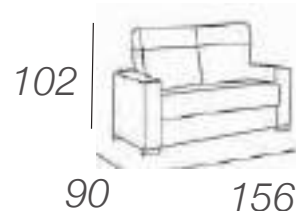

Ancho: 156 CM
Fondo: 90 CM
Alto: 102 CM



CABEZALES RECLINABLES

ASIENTOS DESLIZANTES



Estructura de madera forrada en napa y goma.

Wooden frame covered with imitation leather and foam.
Structure en bois recouvert en napée et mousse.



Respaldos reclinables con fibra hueca y goma picada.

Reclining backrest with hollow fibre and chopped foam.
Dossier inclinable garni de fibre creuse et piquage de mousse.



Asiento extraíble regulable.

Adjustable pull-out seat.
Siège coulissant réglable.



Brazos, asientos y respaldos desfundables.

Removable covers on armrest, seats and backrest.
Acoudoirs, sièges et dossiers déhoussables.



Espuma de poliuretano de alta densidad HR 28kg/m³ más fibra.

28 kg high-density polyurethane foam HR plus fiber.
Mousse polyuréthane haute densité 28 kg/m³. HR + fibres.



Fibra hueca de alta calidad siliconada.

High quality silicone hollow fibre.
Fibres creuses en silicone de haute qualité.



Patas de metal.

Metal legs.
Pieds en metal.



Materiales de primera calidad.

Premium quality materials.
Matériaux de première qualité.



Fabricado con materiales reciclables.

Manufactured with recyclable materials.
Fabriqué en matériaux recyclable.

Messina

Chaiselongue

Tapizados disponibles
serie H y M



Messina

Chaiselongue

Tapizados disponibles
serie H y M

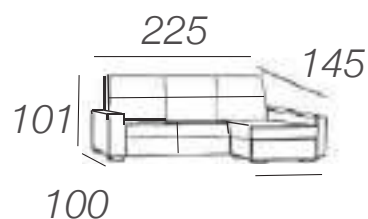

Ancho: 225 CM
Fondo chaise: 145 CM
Alto: 101 CM
Fondo: 100 CM



CABEZALES RECLINABLES
ASIENTOS DESLIZANTES
ARCÓN



Estructura de madera forrada en napa y goma.

Wooden frame covered with imitation leather and foam.
Structure en bois recouvert en napée et mousse.



Respaldos reclinables con fibra hueca y goma picada.

Reclining backrest with hollow fibre and chopped foam.
Dossier inclinable garni de fibre creuse et piquage de mousse.



Asiento extraíble regulable.

Adjustable pull-out seat.
Siège coulissant réglable.



Brazos, asientos y respaldos desenfundables.

Removable covers on armrest, seats and backrest.
Acoudoirs, sièges et dossiers déhoussables.



Espuma de poliuretano de alta densidad HR 25 kg/m³ más fibra.

25 kg/m³ high-density polyurethane foam HR plus fiber.
Mousse polyuréthane haute densité 25 kg/m³. HR + fibres.



Fibra hueca de alta calidad siliconada.

High quality silicone hollow fibre.
Fibres creuses en silicone de haute qualité.



Patas de metal.

Metal legs.
Pieds en metal.



Materiales de primera calidad.

Premium quality materials.
Materiaux de première qualité.



Fabricado con materiales reciclables.

Manufactured with recyclable materials.
Fabriqué en matériaux recyclable.

Faro

Chaiselongue

Tapizados disponibles
serie H y M



Faro

Chaiselongue

Tapizados disponibles
serie H y M

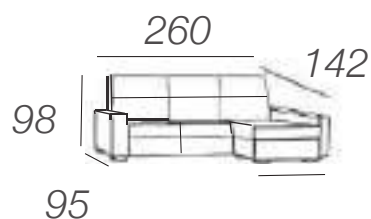

Ancho: 260 CM
Fondo chaise: 142 CM
Alto: 98 CM
Fondo: 95 CM



CABEZALES RECLINABLES
ASIENTOS DESLIZANTES



Estructura de madera forrada en napa y goma.

Wooden frame covered with imitation leather and foam.
Structure en bois recouvert en nappée et mousse.



Respaldos reclinables con fibra hueca y goma picada.

Reclining backrest with hollow fibre and chopped foam.
Dossier inclinable garni de fibre creuse et piquage de mousse.



Asiento extraíble regulable.

Adjustable pull-out seat.
Siège coulissant réglable.



Brazos, asientos y respaldos desenfundables.

Removable covers on armrest, seats and backrest.
Acoudoirs, sièges et dossiers déhoussables.



Espuma de poliuretano de alta densidad HR 25 kg/m³ más fibra.

25 kg/m³ high-density polyurethane foam HR plus fiber.
Mousse polyuréthane haute densité 25 kg/m³. HR + fibres.



Fibra hueca de alta calidad siliconada.

High quality silicone hollow fibre.
Fibres creuses en silicone de haute qualité.



Patas de metal.

Metal legs.
Pieds en metal.



Materiales de primera calidad.

Premium quality materials.
Materiaux de première qualité.



Fabricado con materiales reciclables.

Manufactured with recyclable materials.
Fabriqué en matériaux recyclable.



Ideal para robot aspirador.

Ideal for vacuum robot.
Idéal pour le aspirateur robot.

Faro

Sofá deslizante

Tapizados disponibles
serie H y M



Faro

Sofá deslizante

Tapizados disponibles
serie H y M

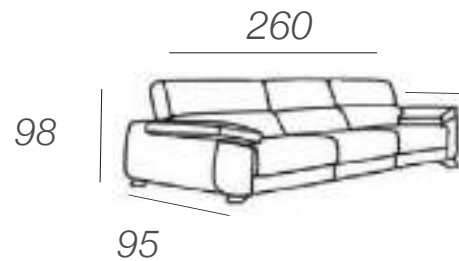

Ancho: 260 CM
Alto: 98 CM
Fondo: 95 CM



Estructura de madera forrada en napa y goma.

Wooden frame covered with imitation leather and foam.
Structure en bois recouvert en napée et mousse.



Asiento extraíble regulable.

Adjustable pull-out seat.
Siège coulissant réglable.



Respaldos reclinables con fibra hueca y goma picada.

Reclining backrest with hollow fibre and chopped foam.
Dossier inclinable garni de fibre creuse et piquage de mousse.



Brazos, asientos y respaldos desenfundables.

Removable covers on armrest, seats and backrest.
Acoudoirs, sièges et dossiers déhoussables.



Espuma de poliuretano de alta densidad HR más fibra.

25 kg high-density polyurethane foam HR plus fiber.
Mousse polyuréthane haute densité 30 kg/m³. HR + fibres.



Fibra hueca de alta calidad siliconada.

High quality silicone hollow fibre.
Fibres creuses en silicone de haute qualité.



Patas de metal.

Metal legs.
Pieds en metal.



Materiales de primera calidad.

Premium quality materials.
Matériaux de première qualité.



Fabricado con materiales reciclables.

Manufactured with recyclable materials.
Fabriqué en matériaux recyclable.



Ideal para robot aspirador.

Ideal for vacuum robot.
Idéal pour le aspirateur robot.

Lisboa

Chaiselongue

Tapizados disponibles
serie H y M



Lisboa

Chaiselongue

Tapizados disponibles
serie H y M

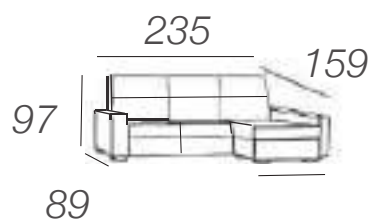

Ancho: 235 CM
Fondo chaise: 159 CM
Alto: 97 CM
Fondo: 89 CM



CABEZALES RECLINABLES
ASIENTOS DESLIZANTES



Estructura de madera forrada en napa y goma.

Wooden frame covered with imitation leather and foam.
Structure en bois recouvert en nappée et mousse.



Respaldos reclinables con fibra hueca y goma picada.

Reclining backrest with hollow fibre and chopped foam.
Dossier inclinable garni de fibre creuse et piquage de mousse.



Asiento extraíble regulable.

Adjustable pull-out seat.
Siège coulissant réglable.



Brazos, asientos y respaldos desenfundables.

Removable covers on armrest, seats and backrest.
Acoudoirs, sièges et dossiers déhoussables.



Espuma de poliuretano de alta densidad HR 25 kg/m³ más fibra.

25 kg/m³ high-density polyurethane foam HR plus fiber.
Mousse polyuréthane haute densité 25 kg/m³. HR + fibres.



Fibra hueca de alta calidad siliconada.

High quality silicone hollow fibre.
Fibres creuses en silicone de haute qualité.



Patas de metal.

Metal legs.
Pieds en metal.



Materiales de primera calidad.

Premium quality materials.
Materiaux de première qualité.



Fabricado con materiales reciclables.

Manufactured with recyclable materials.
Fabriqué en matériaux recyclable.



Ideal para robot aspirador.

Ideal for vacuum robot.
Idéal pour le aspirateur robot.

Iris

Chaiselongue

Tapizados disponibles
serie H y M



Iris

Chaiselongue brazo corto/brazo largo

Tapizados disponibles
serie H y M

BRAZO CORTO

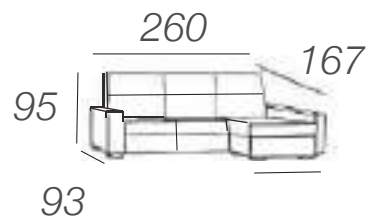

Ancho: 260 CM
Fondo chaise: 167 CM
Alto: 95 CM
Fondo: 93 CM

BRAZO LARGO

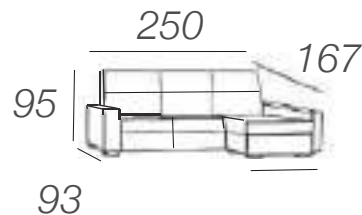

CABEZALES RECLINABLES

ASIENTOS DESLIZANTES

ARCÓN

2 POUFS

BRAZO CORTO ES REVERSIBLE



Estructura de madera forrada en napa y goma.

Wooden frame covered with imitation leather and foam.
Structure en bois recouvert en napée et mousse.



Respaldos reclinables con fibra hueca y goma picada.

Reclining backrest with hollow fibre and chopped foam.
Dossier inclinable garni de fibre creuse et piquage de mousse.



Asiento extraíble regulable.

Adjustable pull-out seat.
Siège coulissant réglable.



Brazos, asientos y respaldos desenfundables.

Removable covers on armrest, seats and backrest.
Acoudoirs, sièges et dossiers déhoussables.



Espuma de poliuretano de alta densidad HR 28kg/m3 más fibra.

28 kg high-density polyurethane foam HR plus fiber.
Mousse polyuréthane haute densité 28 kg/m³. HR + fibres.



Fibra hueca de alta calidad siliconada.

High quality silicone hollow fibre.
Fibres creuses en silicone de haute qualité.



Patas de metal.

Metal legs.
Pieds en metal.



Materiales de primera calidad.

Premium quality materials.
Matériaux de première qualité.



Fabricado con materiales reciclables.

Manufactured with recyclable materials.
Fabriqué en matériaux recyclable.

Madeira

Chaiselongue

Tapizados disponibles
serie H y M



Madeira

Chaiselongue

Tapizados disponibles
serie H y M

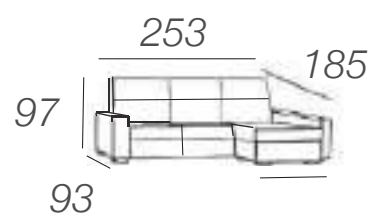

Ancho: 253 CM
Fondo chaise: 185 CM
Alto: 97 CM
Fondo: 93 CM



Estructura de madera forrada en napa y goma.

Wooden frame covered with imitation leather and foam.
Structure en bois recouvert en nappée et mousse.



Respaldos reclinables con fibra hueca y goma picada.

Reclining backrest with hollow fibre and chopped foam.
Dossier inclinable garni de fibre creuse et piquage de mousse.



Asiento extraíble regulable.

Adjustable pull-out seat.
Siège coulissant réglable.



Brazos, asientos y respaldos desenfundables.

Removable covers on armrest, seats and backrest.
Acoudoirs, sièges et dossiers déhoussables.



Espuma de poliuretano de alta densidad HR 25 kg/m³ más fibra.

25 kg high-density polyurethane foam HR plus fiber.
Mousse polyuréthane haute densité 25 kg/m³. HR + fibres.



Fibra hueca de alta calidad siliconada.

High quality silicone hollow fibre.
Fibres creuses en silicone de haute qualité.



Patas en PVC.

PVC legs.
Pieds en PVC.



Materiales de primera calidad.

Premium quality materials.
Materiaux de première qualité.



Fabricado con materiales reciclables.

Manufactured with recyclable materials.
Fabriqué en matériaux recyclable.

Paris

Chaiselongue 3 plazas

Tapizados disponibles
serie H y M



Paris

Chaiselongue 3 plazas fijo/deslizante

Tapizados disponibles
serie H y M

ASIENTO DESLIZANTE O FIJO

CHAISELONGUE DESLIZANTE
REVERSIBLE

SE FABRICA EN DOS MEDIDAS



CHAISELONGUE 3 PLAZAS

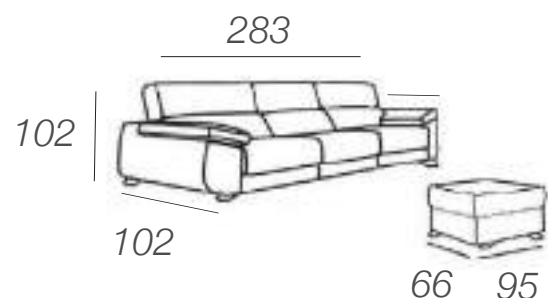

CHAISELONGUE 2 PLAZAS

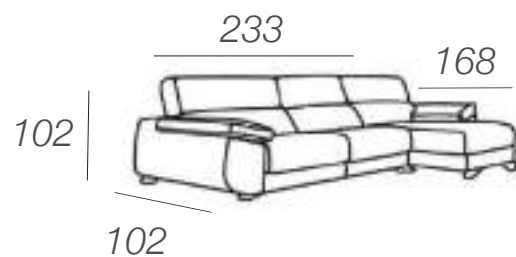
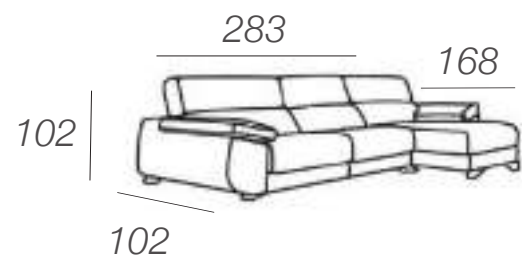
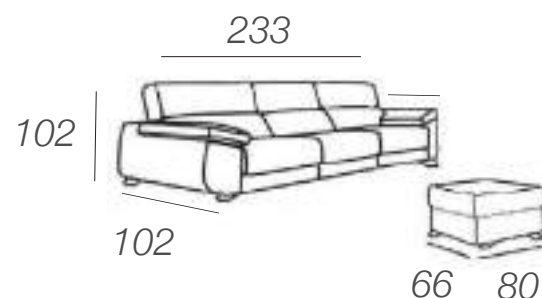

Estructura de madera forrada en napa y goma.

Wooden frame covered with imitation leather and foam.
Structure en bois recouvert en napée et mousse.



Asiento extraíble regulable.

Adjustable pull-out seat.
Siège coulissant réglable.



Brazos, asientos y respaldos desenfundables.

Removable covers on armrest, seats and backrest.
Acoudoirs, sièges et dossiers déhoussables.



Espuma de poliuretano de alta densidad HR 28 kg/m³ más fibra.

28 kg/m³ high-density polyurethane foam HR plus fiber.
Mousse polyuréthane haute densité 28 kg/m³. HR + fibres.



Fibra hueca de alta calidad siliconada.

High quality silicone hollow fiber.
Fibres creuses en silicone de haute qualité.



Patas de metal.

Metal legs.
Pieds en metal.



Materiales de primera calidad.

Premium quality materials.
Matériaux de première qualité.



Fabricado con materiales reciclables.

Manufactured with recyclable materials.
Fabriqué en matériaux recyclable.



Ideal para robot aspirador.

Ideal for vacuum robot.
Idéal pour le aspirateur robot.

Paris

Sofá 3 + 2 plazas

Tapizados disponibles
serie H y M



Paris

Sofá

Tapizados disponibles
serie H y M

3 PLAZAS

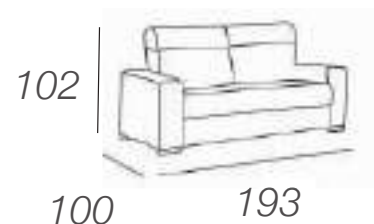

Ancho: 193 CM
Alto: 102 CM
Fondo: 100 CM

2 PLAZAS

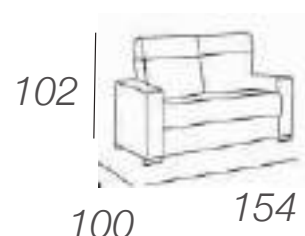

Ancho: 154 CM
Fondo: 100 CM
Alto: 102 CM



ASIENTOS DESLIZANTE O FIJO

RESPALDO RECLINABLE CON ASIENTOS DESLIZANTES



Estructura de madera forrada en napa y goma.

Wooden frame covered with imitation leather and foam.
Structure en bois recouvert en nappée et mousse.



Respaldos reclinables con fibra hueca y goma picada.

Reclining backrest with hollow fibre and chopped foam.
Dossier inclinable garni de fibre creuse et piquage de mousse.



Asiento extraíble regulable.

Adjustable pull-out seat.
Siège coulissant réglable.



Brazos, asientos y respaldos desenfundables.

Removable covers on armrest, seats and backrest.
Acoudoirs, sièges et dossiers déhoussables.



Espuma de poliuretano de alta densidad HR 28kg/m³ más fibra.

28 kg high-density polyurethane foam HR plus fiber.
Mousse polyuréthane haute densité 28 kg/m³. HR + fibres.



Fibra hueca de alta calidad siliconada.

High quality silicone hollow fibre.
Fibres creuses en silicone de haute qualité.



Patas de metal.

Metal legs.
Pieds en metal.



Materiales de primera calidad.

Premium quality materials.
Matériaux de première qualité.



Fabricado con materiales reciclables.

Manufactured with recyclable materials.
Fabriqué en matériaux recyclable.



Ideal para robot aspirador.

Ideal for vacuum robot.
Idéal pour le aspirateur robot.

Genova

Chaiselongue

Tapizados disponibles
serie H y M



Genova

Chaiselongue

Tapizados disponibles
serie H y M

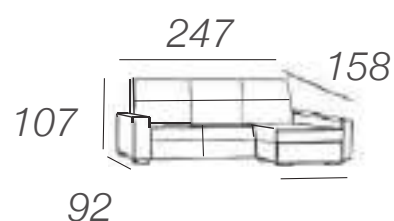

Ancho: 247 CM
Fondo chaise: 158 CM
Alto: 107 CM
Fondo: 92 CM



Estructura de madera forrada en napa y goma.

Wooden frame covered with imitation leather and foam.
Structure en bois recouvert en nappée et mousse.



Brazos, asientos y respaldos desenfundables.

Removable covers on armrest, seats and backrest.
Acoudoirs, sièges et dossiers déhoussables.



Espuma de poliuretano de alta densidad HR 25kg/m³ más fibra.

25 kg high-density polyurethane foam HR plus fiber.
Mousse polyuréthane haute densité 25 kg/m³. HR + fibres.



Fibra hueca de alta calidad siliconada.

High quality silicone hollow fiber.
Fibres creuses en silicone de haute qualité.



Patas de madera.

Wooden legs.
Pieds en bois.



Materiales de primera calidad.

Premium quality materials.
Matériaux de première qualité.



Fabricado con materiales reciclables.

Manufactured with recyclable materials.
Fabriqué en matériaux recyclables.



Chaiselongue reversible.

Reversible corner sofa.
Canapé d'angle réversible.

Operto

Sofá 3 + 2 plazas

Tapizados disponibles
serie H y M



Operto

Sofá

Tapizados disponibles
serie H y M

3 PLAZAS

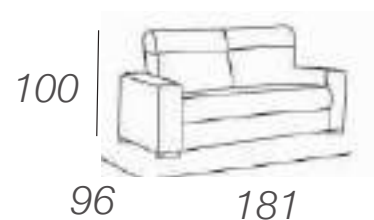

Ancho: 181 CM
Fondo: 96 CM
Alto: 100 CM

2 PLAZAS

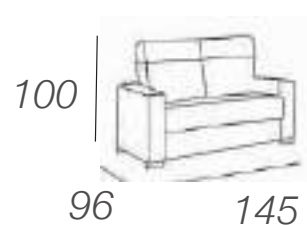

Ancho: 145 CM
Fondo: 96 CM
Alto: 100 CM



Estructura de madera forrada en napa y goma.

Wooden frame covered with imitation leather and foam.
Structure en bois recouvert en nappée et mousse.



Brazos, asientos y respaldos desenfundables.

Removable covers on armrest, seats and backrest.
Acoudoirs, sièges et dossiers déhoussables.



Espuma de poliuretano de alta densidad HR 25kg/m³ más fibra.

25 kg high-density polyurethane foam HR plus fiber.
Mousse polyuréthane haute densité 25 kg/m³. HR + fibres.



Fibra hueca de alta calidad siliconada.

High quality silicone hollow fiber.
Fibres creuses en silicone de haute qualité.



Patas de madera.

Wooden legs.
Pieds en bois.



Materiales de primera calidad.

Premium quality materials.
Matériaux de première qualité.



Fabricado con materiales reciclables.

Manufactured with recyclable materials.
Fabriqué en matériaux recyclable.

Landy

Chaiselongue

Tapizados disponibles
serie H y M



Landy

Chaiselongue

Tapizados disponibles
serie H y M

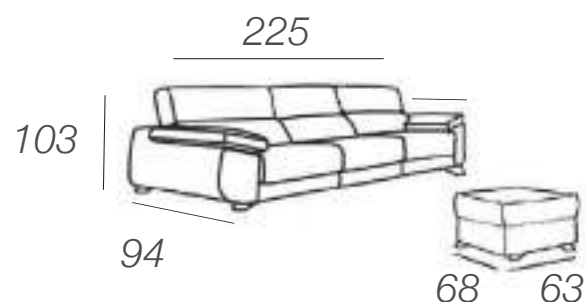

Ancho: 225 CM
Fondo chaise: 162 CM
Alto: 103 CM
Fondo: 94 CM



Estructura de madera forrada en napa y goma.

Wooden frame covered with imitation leather and foam.
Structure en bois recouvert en napée et mousse.



Brazos, asientos y respaldos desenfundables.

Removable covers on armrest, seats and backrest.
Acoudoirs, sièges et dossiers déhoussables.



Espuma de poliuretano de alta densidad HR 25kg/m³ más fibra.

25 kg high-density polyurethane foam HR plus fiber.
Mousse polyuréthane haute densité 25 kg/m³. HR + fibres.



Fibra hueca de alta calidad siliconada.

High quality silicone hollow fiber.
Fibres creuses en silicone de haute qualité.



Patas de madera.

Wooden legs.
Pieds en bois.



Materiales de primera calidad.

Premium quality materials.
Materiaux de première qualité.



Fabricado con materiales reciclables.

Manufactured with recyclable materials.
Fabriqué en matériaux recyclable.



Chaiselongue reversible.

Reversible corner sofa.
Canape d'angle réversible.

Landy

Sofá 3 + 2 plazas

Tapizados disponibles
serie H y M



Landy

Sofá

Tapizados disponibles
serie H y M

3 PLAZAS

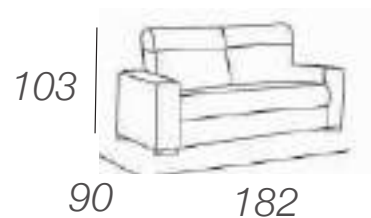

Ancho: 182 CM
Fondo: 90 CM
Alto: 103 CM

2 PLAZAS

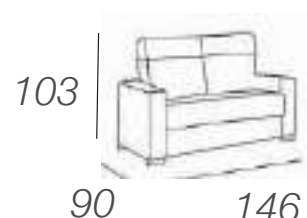

Ancho: 146 CM
Fondo: 90 CM
Alto: 103 CM



Estructura de madera forrada en napa y goma.

Wooden frame covered with imitation leather and foam.
Structure en bois recouvert en napée et mousse.



Brazos, asientos y respaldos desenfundables.

Removable covers on armrest, seats and backrest.
Acoudoirs, sièges et dossiers déhoussables.



Espuma de poliuretano de alta densidad HR 25kg/m³ más fibra.

25 kg high-density polyurethane foam HR plus fiber.
Mousse polyuréthane haute densité 25 kg/m³. HR + fibres.



Fibra hueca de alta calidad siliconada.

High quality silicone hollow fibre.
Fibres creuses en silicone de haute qualité.



Patas de madera.

Wooden legs.
Pieds en bois.



Materiales de primera calidad.

Premium quality materials.
Matériaux de première qualité.



Fabricado con materiales reciclables.

Manufactured with recyclable materials.
Fabriqué en matériaux recyclable.

Eco

Chaiselongue

Tapizados disponibles
serie H y M



Eco

Chaiselongue

Tapizados disponibles
serie H y M

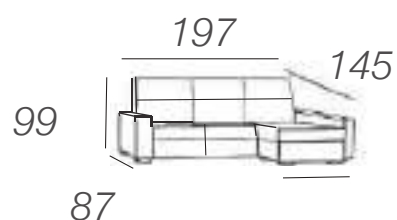

Ancho: 197 CM
Fondo chaise: 145 CM
Alto: 99 CM
Fondo: 87 CM



Estructura de madera forrada en napa y goma.

Wooden frame covered with imitation leather and foam.
Structure en bois recouvert en nappée et mousse.



Brazos, asientos y respaldos desfundables.

Removable covers on armrest, seats and backrest.
Acoudoirs, sièges et dossiers déhoussables.



Espuma de poliuretano de alta densidad HR 25 kg/m³ más fibra.

25 kg high-density polyurethane foam HR plus fiber.
Mousse polyuréthane haute densité 25 kg/m³. HR + fibres.



Fibra hueca de alta calidad siliconada.

High quality silicone hollow fiber.
Fibres creuses en silicone de haute qualité.



Patatas de PVC.

PVC legs.
Pieds en PVC.



Materiales de primera calidad.

Premium quality materials.
Matériaux de première qualité.



Fabricado con materiales reciclables.

Manufactured with recyclable materials.
Fabriqué en matériaux recyclables.



Ideal para robot aspirador.

Ideal for vacuum robot.
Idéal pour le aspirateur robot.

Eco

Sofá 3+2 plazas

Tapizados disponibles
serie H y M



Eco

Sofa 3+2 plazas

Tapizados disponibles
serie H y M



3 PLAZAS

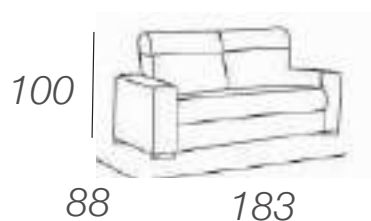

Ancho: 183 CM
Fondo: 88 CM
Alto: 100 CM

2 PLAZAS

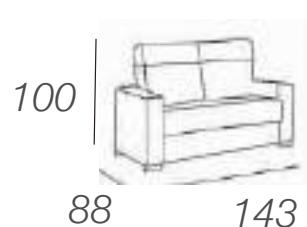

Ancho: 143 CM
Fondo: 88 CM
Alto: 100 CM

ASIENTOS DESLIZANTES O FIJO



Estructura de madera forrada en napa y goma.

Wooden frame covered with imitation leather and foam.
Structure en bois recouvert en nappée et mousse.



Asiento extraíble regulable.

Adjustable pull-out seat.
Siège coulissant réglable.



Brazos, asientos y respaldos desenfundables.

Removable covers on armrest, seats and backrest.
Acoudoirs, sièges et dossiers déhoussables.



Espuma de poliuretano de alta densidad HR 25 kg/m³ más fibra.

25 kg high-density polyurethane foam HR plus fiber.
Mousse polyuréthane haute densité 25 kg/m³. HR + fibres.



Fibra hueca de alta calidad siliconada.

High quality silicone hollow fiber.
Fibres creuses en silicone de haute qualité.



Patas de PVC.

PVC legs.
Pieds en PVC.



Materiales de primera calidad.

Premium quality materials.
Matériaux de première qualité.



Fabricado con materiales reciclables.

Manufactured with recyclable materials.
Fabriqué en matériaux recyclables.



Ideal para robot aspirador.

Ideal for vacuum robot.
Idéal pour le aspirateur robot.

Maxi

Chaiselongue

Tapizados disponibles
serie H y M



Maxi

Chasielongue

Tapizados disponibles
serie H y M

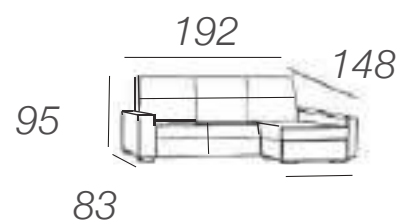

Ancho: 192 CM
Fondo chaise: 148 CM
Alto: 95 CM
Fondo: 83 CM



Estructura de madera forrada en napa y goma.

Wooden frame covered with imitation leather and foam.
Structure en bois recouvert en napée et mousse.



Brazos, asientos y respaldos desfundables.

Removable covers on armrest, seats and backrest.
Acoudoirs, sièges et dossiers déhoussables.



Espuma de poliuretano de alta densidad HR 23kg/m³ más fibra.

23 kg high-density polyurethane foam HR plus fiber.
Mousse polyuréthane haute densité 23 kg/m³. HR + fibres.



Fibra hueca de alta calidad siliconada.

High quality silicone hollow fiber.
Fibres creuses en silicone de haute qualité.



Patas de PVC.

PVC legs.
Pieds de PVC.



Materiales de primera calidad.

Premium quality materials.
Matériaux de première qualité.



Fabricado con materiales reciclables.

Manufactured with recyclable materials.
Fabriqué en matériaux recyclable.



Chasielongue reversible.

Reversible corner sofa.
Canape d'angle réversible.

Níxa

Sofá 3 + 2 plazas

Tapizados disponibles

serie H y M



Nixa

Sofá

Tapizados disponibles
serie H y M

3 PLAZAS

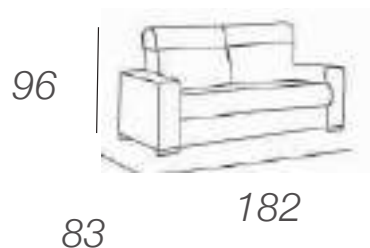

Ancho: 182 CM
Fondo: 83 CM
Alto: 96 CM

2 PLAZAS

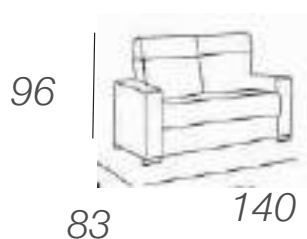

Ancho: 140 CM
Fondo: 83 CM
Alto: 96 CM



Estructura de madera forrada en napa y goma.

Wooden frame covered with imitation leather and foam.
Structure en bois recouvert en napée et mousse.



Brazos, asientos y respaldos desenfundables.

Removable covers on armrest, seats and backrest.
Acoudoirs, sièges et dossiers déhoussables.



Espuma de poliuretano de alta densidad HR 23kg/m³ más fibra.

23 kg high-density polyurethane foam HR plus fiber.
Mousse polyuréthane haute densité 23 kg/m³. HR + fibres.



Fibra hueca de alta calidad siliconada.

High quality silicone hollow fibre.
Fibres creuses en silicone de haute qualité.



2 patas delanteras de metal.

2 front metal legs.
2 pieds métalliques avant.



2 patas traseras en PVC.

2 PVC back legs.
2 pieds arrière en PVC.



Materiales de primera calidad.

Premium quality materials.
Matériaux de première qualité.



Fabricado con materiales reciclables.

Manufactured with recyclable materials.
Fabriqué en matériaux recyclable.

Nilo

Sofá cama

Tapizados disponibles
serie H y M



Nilo

Sofá cama

Tapizados disponibles
serie H y M

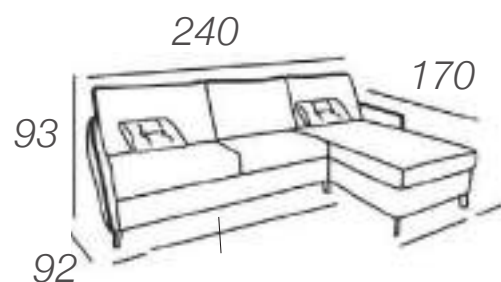

Ancho: 240 CM
Fondo: 92 CM
Alto: 93 CM
Fondo chaise: 170 CM



ARCÓN



Brazos de madera forrada en napa y goma.

Wooden armrest covered with imitation leather and foam.
Acoudoirs en bois recouvert en napée et mousse.



Mecanismo metálico con malla electrosoldada y cincha.

Metallic mechanism with electrowelded mesh and strap.
Mecanisme metalique avec treillis électrosoudé et sangle.



Espuma de poliuretano de alta densidad HR 28 kg/m3 más fibra.

28 kg high-density polyurethane foam HR plus fiber.
Mousse polyuréthane haute densité 28 kg/m3. HR + fibres.



Fibra hueca de alta calidad siliconada.

High quality silicone hollow fiber.
Fibres creuses en silicone de haute qualité.



Cojines, asientos y respaldos desenfundables.

Removable covers on cushion, seats and backrest.
Coussin, sièges et dossiers déhoussables.



Fabricado con materiales reciclables.

Manufactured with recyclable materials.
Fabriqué en matériaux recyclable.



Materiales de primera calidad.

Premium quality materials.
Materiaux de première qualité.



Patas traseras en PVC.

PVC back legs.
Pieds arrière en PVC.

Lara

Sofá cama

Tapizados disponibles
serie H y M



Lara

Sofá cama

Tapizados disponibles
serie H y M

MEDIDA COLCHÓN ASIENTO: 190x90x17 CM



SOFÁ CAMA

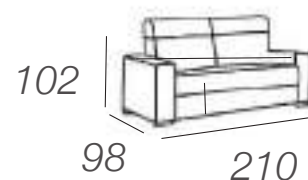

Ancho: 210 CM
Alto: 102 CM
Fondo: 98 CM



CAMA NIDO

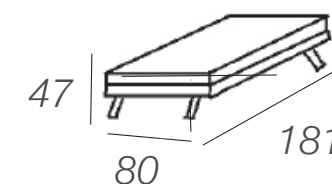

Ancho: 80 CM
Alto: 47 CM
Largo: 181 CM

ASIENTO ABATIBLE CON AVANCE



Brazos de madera forrada en napa y goma.

Wooden armrest covered with imitation leather and foam.
Acoudoirs en bois recouvert en napée et mousse.



Mecanismo metálico con malla electrosoldada.

Metallic mechanism with electrowelded mesh.
Mecanisme metalique avec treillis électrosoudé.



Espuma de poliuretano de alta densidad HR 28 kg/m3 más fibra.

28 kg high-density polyurethane foam HR plus fiber.
Mousse polyuréthane haute densité 28 kg/m3. HR + fibres.



Fibra hueca de alta calidad siliconada.

High quality silicone hollow fiber.
Fibres creuses en silicone de haute qualité.



Cojines, asientos y respaldos desenfundables.

Removable covers on cushion, seats and backrest.
Coussin, sièges et dossiers déhoussables.



Fabricado con materiales reciclables.

Manufactured with recyclable materials.
Fabriqué en matériaux recyclable.



Materiales de primera calidad.

Premium quality materials.
Materiaux de première qualité.



Patatas traseras en PVC.

PVC back legs.
Pieds arrière en PVC.

Celia

Sofá cama
Tapizados disponibles
serie H y M



Celia

Sofá cama

Tapizados disponibles
serie H y M

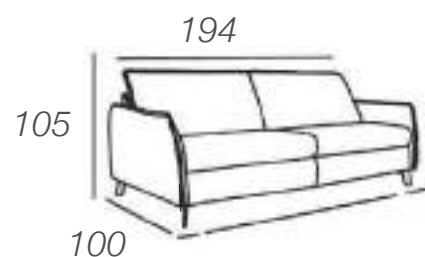

Ancho: 194 CM
Fondo: 100 CM
Alto: 105 CM

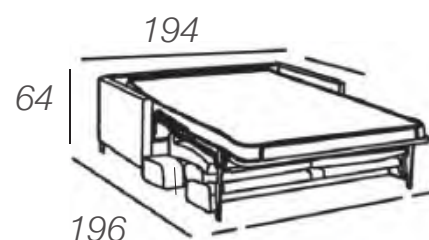

Ancho: 194 CM
Fondo: 196 CM
Alto: 64 CM



Brazos de madera forrada en napa y goma.

Wooden armrest covered with imitation leather and foam.
A en bois recouvert en nappée et mousse.



Asientos y respaldos desfundables.

Removable covers on seats and backrest.
Sièges et dossiers déhoussables.



Mecanismo metálico con malla electro soldada.

Metallic mechanism with electro welded mesh.
Mécanisme métallique avec treillis électro soudé.



Espuma de poliuretano de alta densidad HR 25 kg más fibra.

25 kg high-density polyurethane foam HR plus fiber.
Mousse polyuréthane haute densité 30 kg/m³. HR + fibres.



Fibra hueca de alta calidad siliconada.

High quality silicone hollow fiber.
Fibres creuses en silicone de haute qualité.



Patas de metal.

Metal legs.
Pieds en métal.



Posibilidad de visco elástica en el colchón.

Possibility of memory foam in the mattress.
Possibilité de visco élastique dans le matelas.



Materiales de primera calidad.

Premium quality materials.
Matériaux de première qualité.



Fabricado con materiales reciclables.

Manufactured with recyclable materials.
Fabriqué en matériaux recyclable.



Posibilidad de colchón en 12 o 16 cm de grosor.

Possibility of mattress in 12 or 16 cm thick.
Possibilité de matelas en 12 ou 16 cm d'épaisseur.

Milan

Sofá-cama y Chaiselongue

Tapizados disponibles
serie H y M



Brazo recto 17 cm. Brazo codera 21 cm.



Milán

Sofá

Tapizados disponibles
serie H y M

EL CHAISELONGUE MILAN SÓLO SE FABRICARÁ CON COLCHÓN DE 12 CM.



COLCHÓN 185 x 138 x 12 cm.
COLCHÓN 185 x 138 x 16 cm.



ANCHO BRAZO CODERA 300 CM

Ancho: 292 CM
Fondo: 94 CM
Alto: 100 CM
Fondo chaise: 155 CM

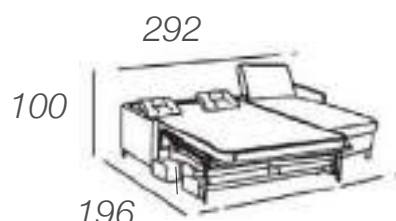

ANCHO BRAZO CODERA 300 CM

Ancho: 292 CM
Fondo: 196 CM
Alto: 100 CM

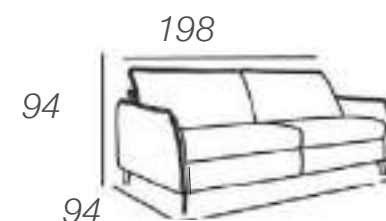

ANCHO BRAZO CODERA 204 CM

Ancho: 198 CM
Fondo: 94 CM
Alto: 94 CM

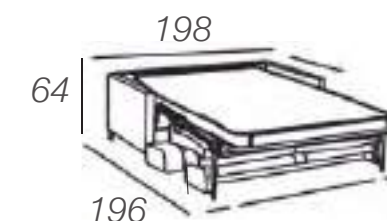

ANCHO BRAZO CODERA 204 CM

Ancho: 198 CM
Fondo: 196 CM
Alto: 64 CM



Brazos de madera forrada en napa y goma.

Wooden armrest covered with imitation leather and foam.
Acoudoirs en bois recouvert en napée et mousse.



Mecanismo metálico con malla electrosoldada.

Metallic mechanism with electrowelded mesh.
Mecanisme metalique avec treillis électrosoudé.



Brazos, asientos y respaldos desfundables.

Removable covers on armrest, seats and backrest.
Acoudoirs, sièges et dossiers déhoussables.



Espuma de poliuretano de alta densidad HR 28kg/m3 más fibra.

28 kg high-density polyurethane foam HR plus fiber.
Mousse polyuréthane haute densité 28 kg/m³. HR + fibres.



Fibra hueca de alta calidad siliconada.

High quality silicone hollow fiber.
Fibres creuses en silicone de haute qualité.



Patas de metal.

Metal legs.
Pieds en metal.



Materiales de primera calidad.

Premium quality materials.
Materiaux de première qualité.



Fabricado con materiales reciclables.

Manufactured with recyclable materials.
Fabriqué en matériaux recyclable.



Posibilidad de colchón en 12 o 16 cm. de grosor.

Possibility of mattress in 12 or 16 cm thick.
Possibilité de matelas en 12 ou 16 dm d'épaisseur.



Posibilidad de visco elástica en el colchón.

Possibility of memory foam in the mattress.
Possibilité de visco elastique dans le matelas.

Praga

Sofá cama

Tapizados disponibles
serie H y M



Praga

Sofá

Tapizados disponibles
serie H y M

EL CHAISELONGUE PRAGA
SÓLO SE FABRICARÁ
CON COLCHÓN DE 12 CM.



COLCHÓN 185 x 138 x 12 cm.
COLCHÓN 185 x 138 x 16 cm.

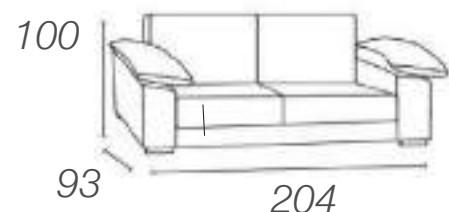

Ancho: 204CM
Fondo: 93 CM
Alto: 100 CM

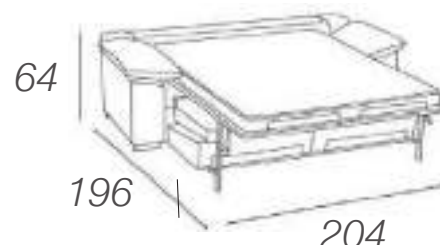

Ancho: 204 CM
Fondo: 196 CM
Alto: 64 CM

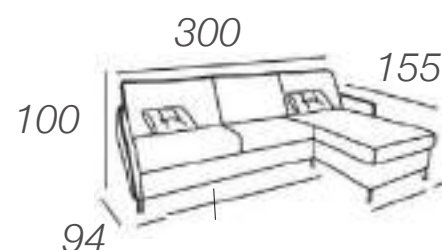

Ancho: 300 CM
Fondo: 94 CM
Alto: 100 CM
Fondo chaise: 155 CM

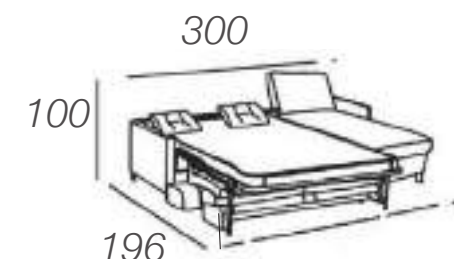

Ancho: 300 CM
Fondo: 196 CM
Alto: 100 CM



Brazos de madera forrada en napa y goma.

Wooden armrest covered with imitation leather and foam.
Acoudoirs en bois recouvert en nappée et mousse.



Mecanismo metálico con malla electrosoldada.

Metalic mechanism with electrowelded mesh.
Mecanisme metalique avec treillis électrosoudé.



Brazos, asientos y respaldos desenfundables.

Removable covers on armrest, seats and backrest.
Acoudoirs, sièges et dossiers déhoussables.



Espuma de poliuretano de alta densidad HR 28kg/m³ más fibra.

28 kg high-density polyurethane foam HR plus fiber.
Mousse polyuréthane haute densité 28 kg/m³. HR + fibres.



Fibra hueca de alta calidad siliconada.

High quality silicone hollow fibre.
Fibres creuses en silicone de haute qualité.



Patas de metal.

Metal legs.
Pieds en metal.



Materiales de primera calidad.

Premium quality materials.
Materiaux de première qualité.



Fabricado con materiales reciclables.

Manufactured with recyclable materials.
Fabriqué en matériaux recyclable.



Posibilidad de colchón en 12 o 16 cm. de grosor.

Possibility of mattress in 12 or 16 cm thick.
Possibilité de matelas en 12 ou 16 dm d'épaisseur.



Posibilidad de visco elástica en el colchón.

Possibility of memory foam in the mattress.
Possibilité de visco elastique dans le matelas.

Corea

Sofá cama

Tapizados disponibles
serie A y H (Junio, Zafiro y Cristal)



Aris Atlas y Corea

Sofá

Tapizados disponibles
serie A y H (Junio, Zafiro y Cristal)

MEDIDA COLCHÓN GOMA 188x126x11,5
MEDIDA COLCHÓN ARBOLAT 25 183x126x12
MEDIDA COLCHÓN ARBOLAT 30 183x126x12

SOFÁ CAMA COREA



Patas de metal

MEDIDA CAMA ABIERTA 232x128x44

SOFÁ CAMA ATLAS



MEDIDA CAMA ABIERTA 225x128x44

SOFÁ CAMA ARIS



MEDIDA CAMA ABIERTA 223x128x44

LOS MODELOS COREA, ATLAS Y ARIS EN LAS TELAS LEVANTE, ZAFIRO Y JUNIO IRAN COMBINADAS CON ALBA CHOCO Y ALBA NEGRO EN LA BASE Y BRAZOS. SÓLO EN LA TELA CRISTAL SE PODRÁ FABRICAR TODO EN LA MISMA TELA

SOFÁ CAMA COREA

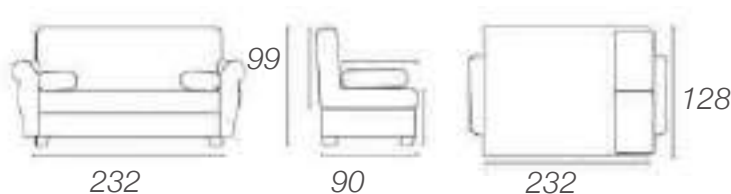

Ancho: 232 CM
Fondo: 90 CM
Alto: 99 CM

SOFÁ CAMA ATLAS

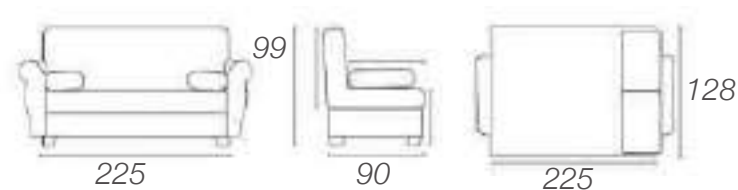

Ancho: 225 CM
Fondo: 90 CM
Alto: 99 CM

SOFÁ CAMA ARIS

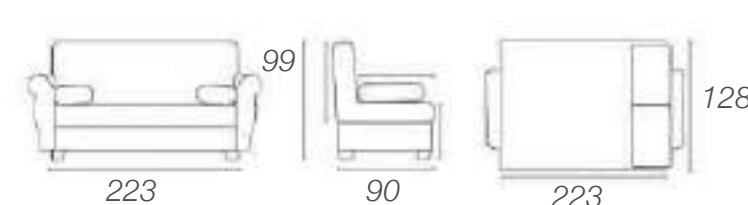

Ancho: 223 CM
Fondo: 90 CM
Alto: 99 CM



Sofá cama bisagra automática con dos posiciones.

Sofa bed with automatic hinge with two positions.
Canapé-lit avec charnière automatique avec deux positions.



Brazos de madera forrada en napa y goma.

Wooden armrest covered with imitation leather and foam.
Accoudoirs en bois recouvert en napée et mousse.



Edredón desenfundable.

Removable duvet.
Housse déhoussable.



Bastidores metálicos con lamas de haya y eucalipto.

Metallic structure with beech and eucalyptus wood sheets.
Armature métallique avec lattes en hêtre et eucalyptus.



Colchón goma, Arbolat 25 kg/m³ o Arbolat 30 kg/m³.

Foam mattresses, Arbolat 25 kg/m³ or Arbolat 30 kg/m³.
Matelas en mousse, Arbolat 25 kg/m³ ou Arbolat 30 kg/m³.



Fibra hueca de alta calidad siliconada.

High quality silicone hollow fibre.
Fibres creuses en silicone de haute qualité.



Patas de madera.

Wooden legs.
Pieds en bois.



Base en tablero de partículas y madera forrada en napa tapizado.

Wooden base covered with imitation leather and upholstered.
Base en panneaux de particules et en bois recouvert en napée et tapissé.

Cenit Nórdico

Sofá

Tapizados disponibles
serie A y H (Junio, Zafiro y Cristal)



Cenit Nórdico

Sofá

Tapizados disponibles
serie A y H (Junio, Zafiro y Cristal)



COLCHÓN GOMA

COLCHÓN 188x126x11,5

CAMA ABIERTA 188x128x44

COLCHÓN ARB.25 Y ARB.30

COLCHÓN 188x126x12

CAMA ABIERTA 188x128x47

CENIT NÓRDICO

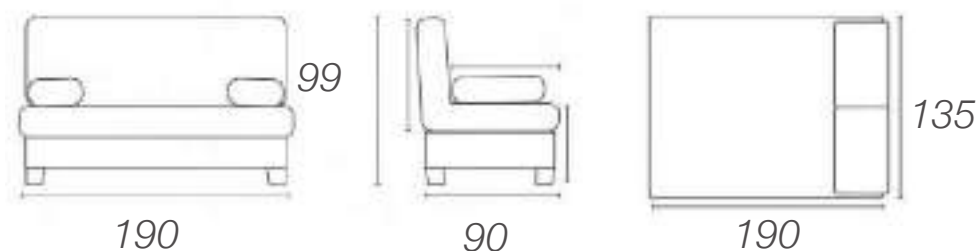

 **Sofá cama bisagra automática con dos posiciones.**
Sofa bed with automatic hinge with two positions.
Canapé-lit avec charnière automatique avec deux positions.

 **Edredón desenfundable.**
Removable duvet.
Housse déhoussable.

 **Bastidores metálicos con lamas de haya y eucalipto.**
Metallic structure with beech and eucalyptus wood sheets.
Armature métallique avec lattes en hêtre et eucalyptus.

 **Colchón goma, Arbolat 25 kg/m³ o Arbolat 30 kg/m³.**
Foam mattress, Arbolat 25 kg/m³ or Arbolat 30 kg/m³.
Matelas en mousse, Arbolat 25 kg/m³ ou Arbolat 30 kg/m³.

 **Fibra hueca de alta calidad siliconada.**
High quality silicone hollow fibre.
Fibres creuses en silicone de haute qualité.

 **Patas de madera.**
Wooden legs.
Pieds en bois.

 **Base en tablero de partículas y madera forrada en napa tapizado.**
Wooden base covered with imitation leather and upholstered.
Base en panneaux de particules et en bois recouvert en napée et tapissé.

Cenit S4 y S5

Sofá cama

Tapizados disponibles
serie A y H (Junio, Zafiro y Cristal)



Cenit

Sofá

Tapizados disponibles
serie A y H (Junio, Zafiro y Cristal)

SERIE 4 y 5



SERIE 4 Y SERIE 5

COLCHÓN 190x127x17

CAMA ABIERTA 193x130x50

SERIE 5 COLCHÓN GOMA HR 30 KG/M3 + VISCO

SERIE 4 COLCHÓN GOMA HR 30 KG/M3

SOFÁ CAMA CENIT SERIE 4 Y 5

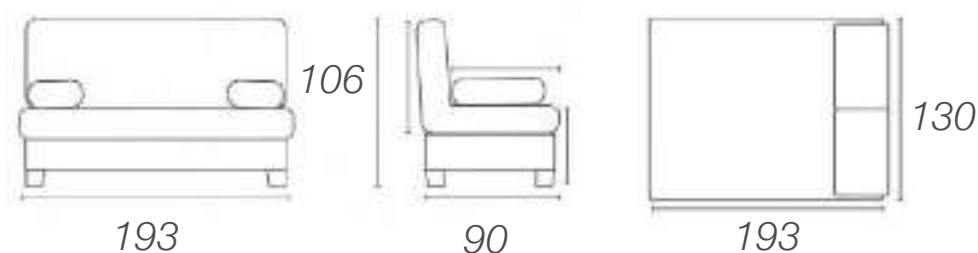

Ancho: 193 CM

Fondo: 90 CM

Alto: 106 CM



Sofá cama bisagra automática con dos posiciones.

Sofa bed with automatic hinge with two positions.

Canapé-lit avec charnière automatique avec deux positions.



Edredón desenfundable.

Removable duvet.

Housse déhoussable.



Bastidores metálicos con lamas de haya y eucalipto.

Metallic structure with beech and eucalyptus wood sheets.

Armature métallique avec lattes en hêtre et eucalyptus.



Colchón S4 unibloc 30 kg/m3, S5 unibloc 30 kg/m3 + visco.

Mattres S4 unibloc 30 kg/m3, S5 unibloc 30 kg/m3 + memory foam.

Matelas S4 unibloc 30 kg/m3, S5 unibloc 30 kg/m3 + visco elastique.



Fibra hueca de alta calidad siliconada.

High quality silicone hollow fibre.

Fibres creuses en silicone de haute qualité.



Patas de metal.

Metal legs.

Pieds en metal.



Base en tablero de partículas y madera forrada en napa tapizado.

Wooden base covered with imitation leather and upholstered.

Base en panneaux de particules et en bois recouvert en napée et tapissé.



Posibilidad de visco elástica en el colchón.

Possibility of memory foam in the mattress.

Possibilité de visco elastique dans le matelas.

Cenit S3 y S2

Sofá cama

Tapizados disponibles
serie A y H (Junio, Zafiro y Cristal)



Cenit

Sofá cama

Tapizados disponibles
serie A y H (Junio, Zafiro y Cristal)

SERIE 1



SERIE 2 - SERIE 3



SERIE 1

SERIE 2 Y SERIE 3

COLCHÓN	188x126x11,5	COLCHÓN	188x126x12
CAMA ABIERTA	188x128x44	CAMA ABIERTA	188x128x47

SERIE 2: Colchón Arbolat 25

SERIE 3: Colchón Arbolat 30

SOFÁ CAMA CENIT SERIE 1

SOFÁ CAMA CENIT SERIE 2 Y SERIE 3

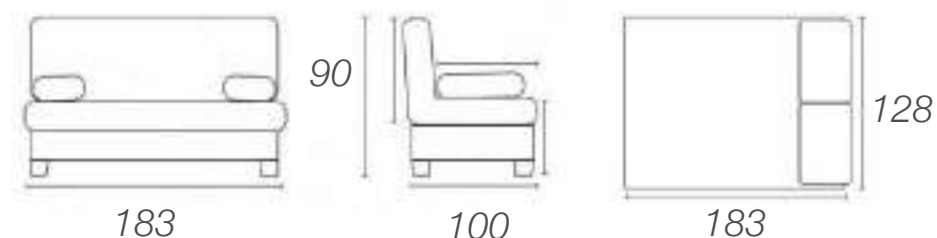
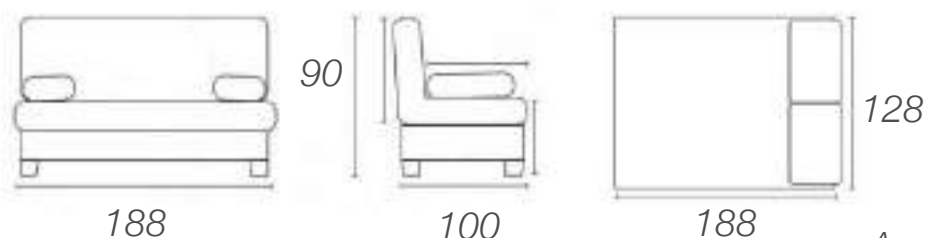

Ancho: 188 CM
Fondo: 90 CM
Alto: 100 CM

Ancho: 183 CM
Fondo: 100 CM
Alto: 90 CM



Sofá cama bisagra automática con dos posiciones.

Sofa bed with automatic hinge with two positions.
Canapé-lit avec charnière automatique avec deux positions.



Edredón desenfundable.

Removable duvet.
Housse déhoussable.



Bastidores metálicos con lamas de haya y eucalipto.

Metallic structure with beech and eucalyptus wood sheets.
Armature métallique avec lattes en hêtre et eucalyptus.



Colchón goma, Arbolat 25 kg/m³ o Arbolat 30 kg/m³.

Foam mattresses, Arbolat 25 kg/m³ or Arbolat 30 kg/m³.
Matelas en mousse, Arbolat 25 kg/m³ ou Arbolat 30 kg/m³.



Fibra hueca de alta calidad siliconada.

High quality silicone hollow fibre.
Fibres creuses en silicone de haute qualité.



Patas de metal. (SERIE 2 y 3)

Metal legs.
Pieds en metal.



Patas de PVC. (SERIE 1)

PVC legs.
Pieds en PVC.



Base en tablero de partículas y madera forrada en napa tapizado.

Wooden base covered with imitation leather and upholstered.
Base en panneaux de particules et en bois recouvert en napée et tapissé.

Flandes

Sofá cama

Tapizados disponibles
serie A y H

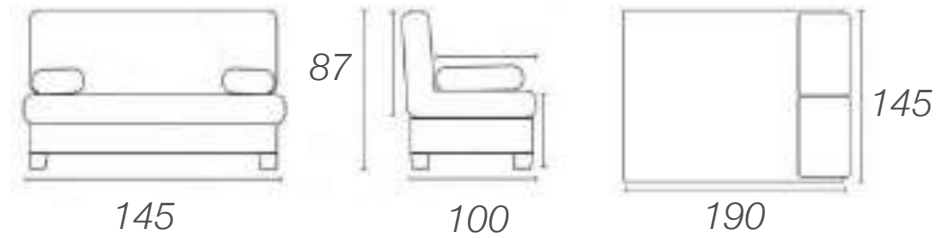

Ancho: 145 CM
Fondo: 100 CM
Alto: 87 CM

COCHÓN 190 X 140 X 12 CM



Edredón desenfundable.

Removable duvet.
Housse déchoussable.



Colchón arbolat 25kg/m³ o arbolat 30kg/m³.

Mattres arbolat 25kg/m³ or arbolat 30kg/m³.
Mattres arbolat 25kg/m³ ou arbolat 30kg/m³.



Fibra hueca de alta calidad siliconada.

High quality silicone hollow fibre.
Fibres creuses en silicone de haute qualité.



Estructura metálica con 16 lamas de haya.

Metalic frame with 16 beech wood sheets.
Armature metalique avec 16 lattes en hêtre.

Puf cama

Tapizados disponibles
serie A

PUF CERRADO: 64 X 81 X 50 CM

PUF ABIERTO: 182 X 80 X 36 CM

COLCHÓN: 182 X 80 X 9 CM



Edredón desenfundable.

Removable duvet.
Housse déhousable.



Colchón goma HR.

Foam mattress HR.
Matelas en mousse HR.



Fibra hueca de alta calidad siliconada.

High quality silicone hollow fibre.
Fibres creuses en silicone de haute qualité.



Estructura metálica con lamas de haya y eucalipto.

Metalic frame with beech and eucalyptus wood sheets.
Armature metalique avec lattes en hêtre et eucalyptus.

Nórdicos

Sofá 3+2 y butaca

Tapizados disponibles
serie H y M



Butacas

Nórdicas

Tapizados disponibles
serie H y M

BUTACA

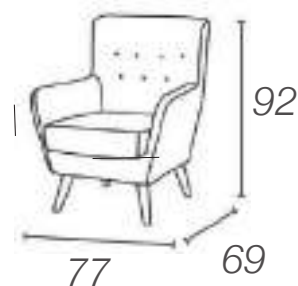

Medidas base
Ancho: 77 CM
Fondo: 69 CM
Alto: 92 CM



2 PLAZAS

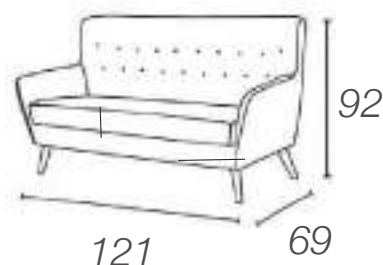

Medidas base
Ancho: 121 CM
Fondo: 69 CM
Alto: 92 CM



3 PLAZAS

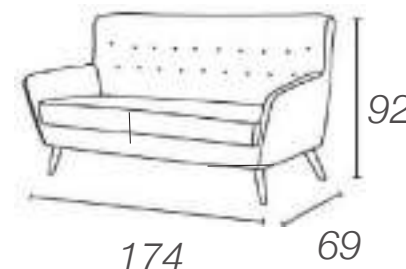

Medidas base
Ancho: 174 CM
Fondo: 69 CM
Alto: 92 CM



Estructura de madera forrada en napa y goma.

Wooden frame covered with imitation leather and foam.
Structure en bois recouvert en napée et mousse.



Espuma de poliuretano de alta densidad HR 25kg/m³ más fibra.

25 kg high-density polyurethane foam HR plus fiber.
Mousse polyuréthane haute densité 25 kg/m³. HR + fibres.



Materiales de primera calidad.

Premium quality materials.
Matériaux de première qualité.



Asientos desenfundables.

Removable covers on seats.
Sièges déhoussables.



Fibra hueca de alta calidad siliconada.

High quality silicone hollow fibre.
Fibres creuses en silicone de haute qualité.



Fabricado con materiales reciclables.

Manufactured with recyclable materials.
Fabriqué en matériaux recyclable.



Patas de madera.

Wooden legs.
Pieds en bois.

Butacas

Tapizados disponibles
serie H y M

Butaca fija y cunera



Butacas

Tapizados disponibles
serie H y M

BUTACA FIJA

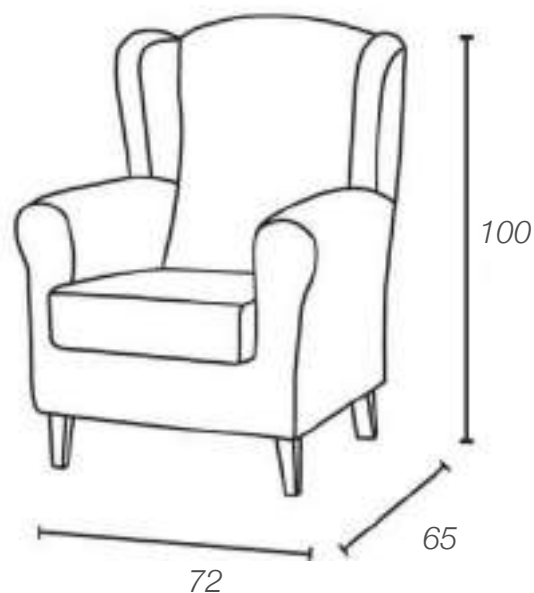

BUTACA CUNERA

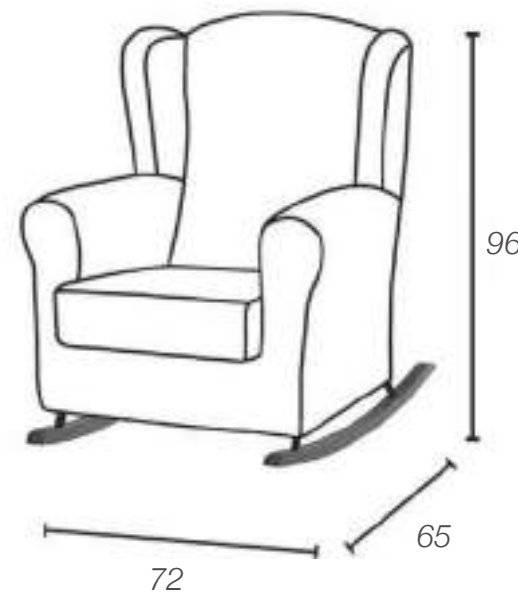

Estructura de madera forrada en napa y goma.

Wooden frame covered with imitation leather and foam.
Structure en bois recouvert en nappée et mousse.



Asientos desenfundables.

Removable covers on seats.
Sièges déhoussables.



Espuma de poliuretano de alta densidad HR 25kg/m³ más fibra.

25 kg high-density polyurethane foam HR plus fiber.
Mousse polyuréthane haute densité 25 kg/m³. HR + fibres.



Fibra hueca de alta calidad siliconada.

High quality silicone hollow fiber.
Fibres creuses en silicone de haute qualité.



Patas de madera.

Wooden legs.
Pieds en bois.



Materiales de primera calidad.

Premium quality materials.
Matériaux de première qualité.



Fabricado con materiales reciclables.

Manufactured with recyclable materials.
Fabriqué en matériaux recyclables.

Sillones Relax

Mecanismo
de empuje y
power lift

Tapizados disponibles
serie H y M



Sillones

Tapizados disponibles
serie H y M

RELAX CONFORT MECANISMO EMPUJE

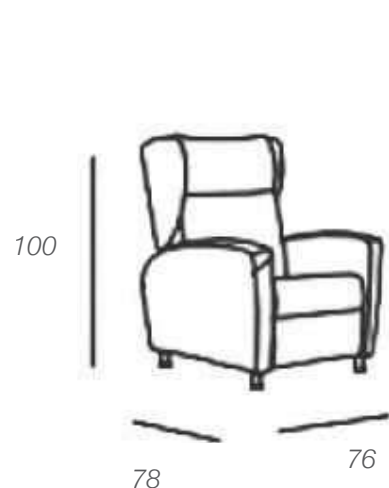

Opción Power Lift

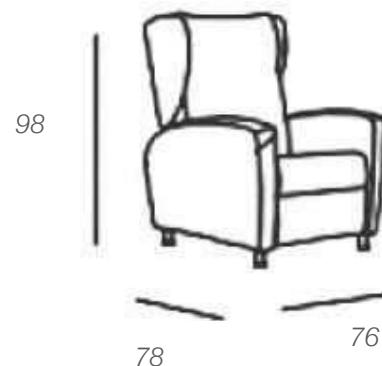

RELAX OREJERO MECANISMO EMPUJE



SÓLO MECANISMO DE EMPUJE



Estructura de madera forrada en napa y goma.

Wooden frame covered with imitation leather and foam.
Structure en bois recouvert en nappée et mousse.



Relax confort y respaldos desenfundables.

Removable covers on relax confort backrest.
Relax confort dossiers déhoussables.



Espuma de poliuretano de alta densidad HR 25kg/m³ más fibra.

25 kg high-density polyurethane foam HR plus fiber.
Mousse polyuréthane haute densité 25 kg/m³. HR + fibres.



Fibra hueca de alta calidad siliconada.

High quality silicone hollow fiber.
Fibres creuses en silicone de haute qualité.



Patas de PVC.

PVC legs.
Pieds en PVC.



Materiales de primera calidad.

Premium quality materials.
Matériaux de première qualité.



Fabricado con materiales reciclables.

Manufactured with recyclable materials.
Fabriqué en matériaux recyclable.



Mecanismo europeo de alta calidad.

High quality European mechanism.
Mécanisme européen de haute qualité.

*Sillón Relax
Nápoles*



*Sillón Relax
Báldu*



Sillón relax

SILLÓN RELAX NÁPOLES



MECANISMO DE EMPUJE

SILLÓN RELAX BALDU



MECANISMO RELAX CON 2 MOTORES
O RELAX POWER-LIFT



Estructura de madera forrada en napa y goma.

Wooden frame covered with imitation leather and foam.
Structure en bois recouvert en nappée et mousse.



Brazos, asientos y respaldos desenfundables.

Removable covers on armrest, seats and backrest.
Acoudoirs, sièges et dossiers déhoussables.



Espuma de poliuretano de alta densidad HR más fibra.

High-density polyurethane foam HR plus fiber.
Mousse polyuréthane haute densité HR + fibres.



Fibra hueca de alta calidad siliconada.

High quality silicone hollow fiber.
Fibres creuses en silicone de haute qualité.



Patas de metal.

Metal legs.
Pieds en metal.



Materiales de primera calidad.

Premium quality materials.
Matériaux de première qualité.



Fabricado con materiales reciclables.

Manufactured with recyclable materials.
Fabriqué en matériaux recyclable.



Mecanismo europeo de alta calidad.

High quality European mechanism.
Mécanisme européen de haute qualité.

Cabeceiros



Cabeceiros

CABECERO CUADROS

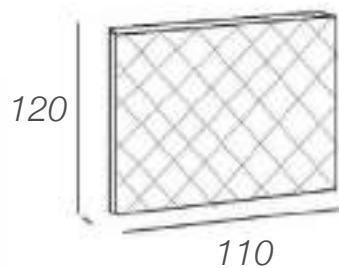

110

120

155

CABECERO ROMBOS



Estructura de madera

Wooden frame.
Structure en bois.



Fibra hueca de alta calidad siliconada.

High quality silicone hollow fibre.
Fibres creuses en silicone de haute qualité.



Patas de PVC.

PVC legs.
Pieds en PVC.



Materiales de primera calidad.

Premium quality materials.
Materiaux de première qualité.



Fabricado con materiales reciclables.

Manufactured with recyclable materials.
Fabriqué en matériaux recyclable.

Serie L

Albi



ACERO



PLATA



CRUDO



PIEDRA

Composición / Composition:

100% Poliéster

Peso / Weight: **630 gr/ml**

Ancho / Width: **140 cm.**

Resistencia a la abrasión / Abrasion resistance:

>25.000 ciclos

Solidez al frote / Rubbing fastness: **4**

ISO 105 C06:2010 B2S GRADE

Solidez a la luz / Light fastness: **4**

Solidez al frote húmedo / Rubbing fastness: **4**

ISO 105 C06:2010 B2S GRADE

Solidez al lavado / Washing fastness: **4**

ISO 3759:2011, ISO 6330:212 (5N TUMBLE DRY)

ISO 5077:2007 GRADE

Serie L

Coimbra

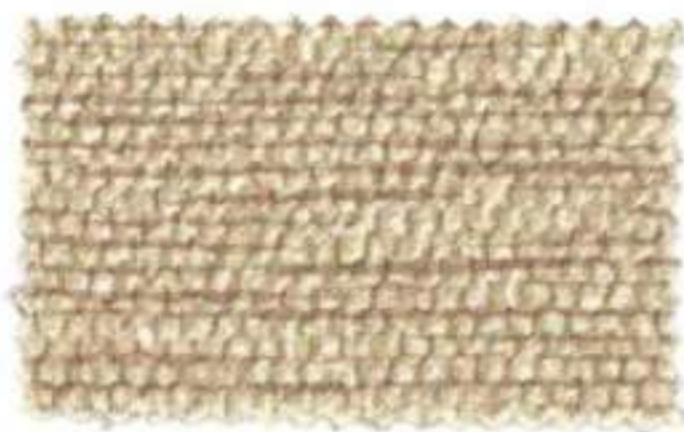

CAMEL



MARFIL

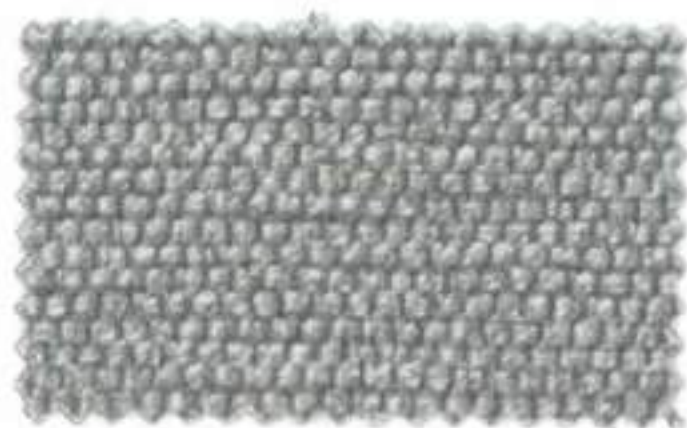

PIEDRA

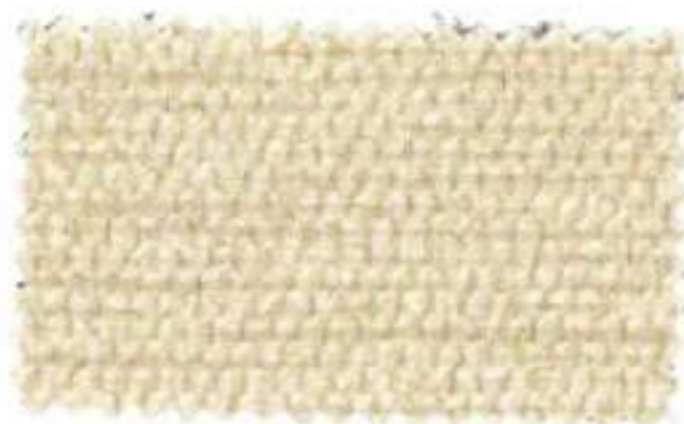

BEIGE



ANTRACITA

Composición / Composition:
100% Poliéster

Peso / Weight: **560 gr/ml**

Ancho / Width: **140 cm.**

Resistencia a la abrasión / Abrasion resistance:
>40.000 ciclos

Solidez al frote / Rubbing fastness: **4-5**
ISO 105 C08:2010 B2S GRADE

Solidez a la luz / Light fastness: **4**

Solidez al frote húmedo / Rubbing fastness: **4**
ISO 105 C06:2010 B2S GRADE

Solidez al lavado / Washing fastness: **4**
ISO 3759:2011, ISO 6330:212 (5N TUMBLE DRY)
ISO 5077:2007 GRADE

Serie L

Lotus



CRUDO 2



PLATA 16



ARENA 4



CEMENTO 17

Composición / Composition:

100% Poliéster

Peso / Weight: **518 gr/ml**

Ancho / Width: **140 cm.**

Resistencia a la abrasión / Abrasion resistance:

>40.000 ciclos

Solidez al frote / Rubbing fastness: **4-5**

ISO 105 C06:2010 B2S GRADE

Solidez a la luz / Light fastness: **3-4**

Solidez al frote húmedo / Rubbing fastness: **4**

ISO 105 C06:2010 B2S GRADE

Solidez al lavado / Washing fastness: **4**

ISO 3759:2011, ISO 6330:212 (5N TUMBLE DRY)

ISO 5077:2007 GRADE

Serie H

Blue



BLANCO



BEIGE



LIMÓN



VERDE PASTEL



AZUL



TRUFA



PERLA



CENIZA

Composición / Composition:
100% **Poliéster**

Peso / Weight: **440 gr/ml**

Ancho / Width: **140 cm.**

Resistencia a la abrasión / Abrasion resistance:
>40.000 ciclos

Solidez al frote / Rubbing fastness: **4-5**
ISO 105 C08:2010 B2S GRADE

Solidez a la luz / Light fastness: **4-5**

Solidez al frote húmedo / Rubbing fastness: **4**
ISO 105 C06:2010 B2S GRADE

Solidez al lavado / Washing fastness: **4-5**
ISO 3759:2011, ISO 6330:212 (5N TUMBLE DRY)
ISO 5077:2007 GRADE

Serie H

Cátabria



BEIGE 2



TIERRA 4



CAFÉ 5

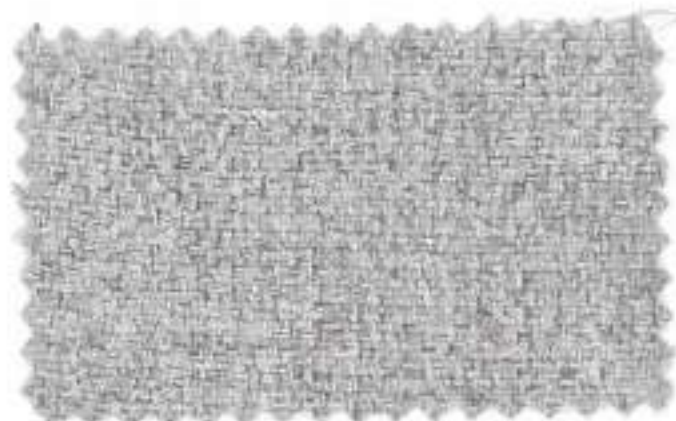

PLATA 14

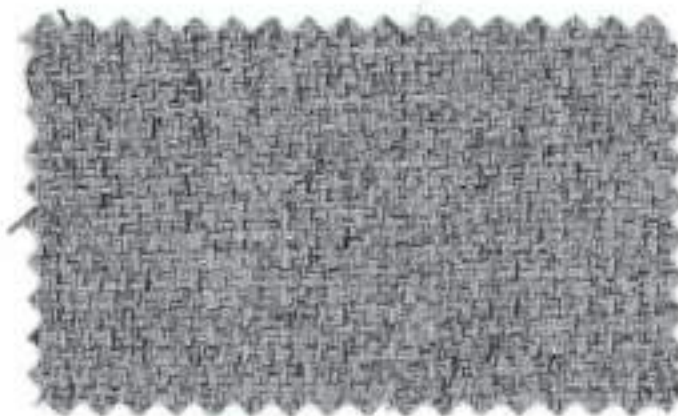

GRIS 15



MARENGO 18

Composición / Composition:
100% Poliéster

Peso / Weight: **378 gr/ml**

Ancho / Width: **140 cm.**

Resistencia a la abrasión / Abrasion resistance:
>50.000 ciclos

Solidez al frote / Rubbing fastness: **4-5**
ISO 105 C06:2010 B2S GRADE

Solidez a la luz / Light fastness: **4**

Solidez al frote húmedo / Rubbing fastness: **4-5**
ISO 105 C06:2010 B2S GRADE

Solidez al lavado / Washing fastness: **3-4**
ISO 3759:2011, ISO 6330:212 (5N TUMBLE DRY)
ISO 5077:2007 GRADE

Serie H

Hada



PLATA



ANTRACITA



BEIGE



AZUL



CRUDO

Composición / Composition:
100% Poliéster

Peso / Weight: **535 gr/ml**

Ancho / Width: **142 cm.**

Resistencia a la abrasión / Abrasion resistance:
>35.000 ciclos

Solidez al frote / Rubbing fastness: **4-5**
ISO 105 C08:2010 B2S GRADE

Solidez a la luz / Light fastness: **3-4**

Solidez al frote húmedo / Rubbing fastness: **4**
ISO 105 C06:2010 B2S GRADE

Solidez al lavado / Washing fastness: **4**
ISO 3759:2011, ISO 6330:212 (5N TUMBLE DRY)
ISO 5077:2007 GRADE

Serie H

Magnolia



CREMA



PIEDRA



PLOMO



CEMENTO



ROJO

Composición / Composition:
100% Poliéster

Peso / Weight: **476 gr/ml**

Ancho / Width: **140 cm.**

Resistencia a la abrasión / Abrasion resistance:
>30.000 ciclos

Solidez al frote / Rubbing fastness: **4-5**
ISO 105 C06:2010 B2S GRADE

Solidez a la luz / Light fastness: **3-4**

Solidez al frote húmedo / Rubbing fastness: **4**
ISO 105 C06:2010 B2S GRADE

Solidez al lavado / Washing fastness: **3-4**
ISO 3759:2011, ISO 6330:212 (5N TUMBLE DRY)
ISO 5077:2007 GRADE

Serie H

Kayra



CAFE



VISÓN



MARENGO

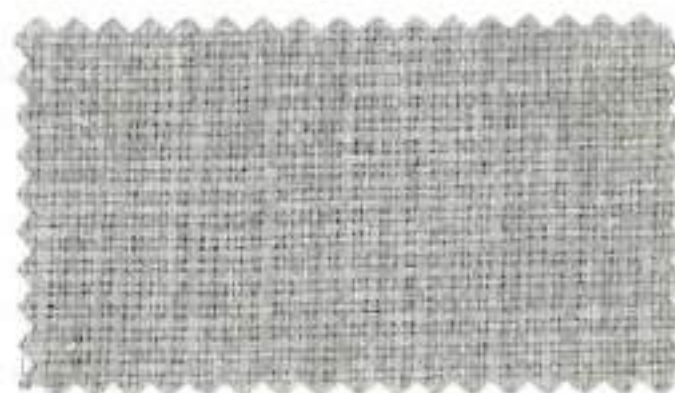

PERLA

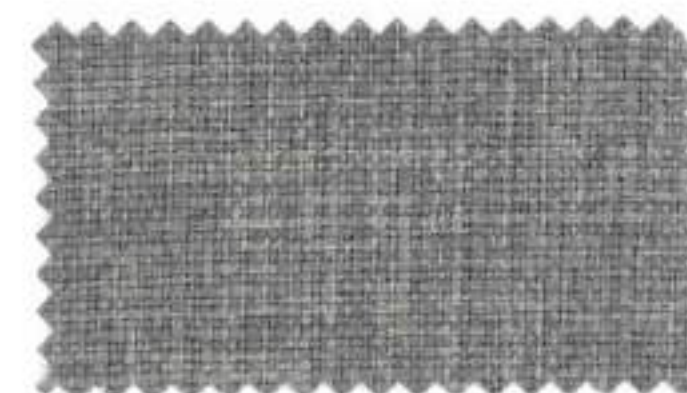

GRIS

Composición / Composition:

100% Poliéster

Peso / Weight: 448 gr/ml

Ancho / Width: 140 cm.

Resistencia a la abrasión / Abrasion resistance:

>35.000 ciclos

Solidez al frote / Rubbing fastness: 4-5

ISO 105 C06:2010 B2S GRADE

Solidez a la luz / Light fastness: 3-4

Solidez al frote húmedo / Rubbing fastness: 4-5

ISO 105 C06:2010 B2S GRADE

Solidez al lavado / Washing fastness: 4

ISO 3759:2011, ISO 6330:212 (5N TUMBLE DRY)

ISO 6077:2007 GRADE

Serie H

Nido



BEIGE



CAFÉ



ROSA



CHOCO



VERDE



TURQUESA



PERLA



MARENGO



AMARILLO



ROJO

Composición / Composition:

100% Poliéster

Peso / Weight: 518 gr/mi

Ancho / Width: 140 cm.

Resistencia a la abrasión / Abrasion resistance:

>25.000 ciclos

Solidez al frote / Rubbing fastness: 4-5

ISO 105 C06:2010 B2S GRADE

Solidez a la luz / Light fastness: 3-4

Solidez al frote húmedo / Rubbing fastness: 4

ISO 105 C06:2010 B2S GRADE

Solidez al lavado / Washing fastness: 4

ISO 3759:2011, ISO 6330:212 (5N TUMBLE DRY)

ISO 5077:2007 GRADE

Serie H

Orion



BEIGE



CAFÉ

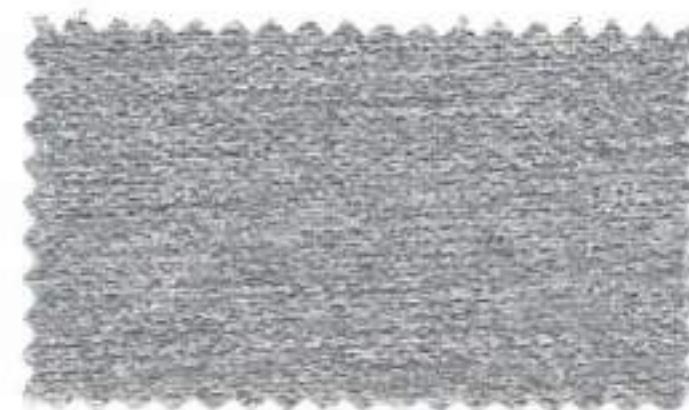

PERLA



GRIS



MARENGO



PIEDRA

Composición / Composition:

85% Poliéster 15% Nylon

Peso / Weight: 504 gr/m²

Ancho / Width: 140 cm.

Resistencia a la abrasión / Abrasion resistance:

>30.000 ciclos

Solidez al frote / Rubbing fastness: 4-5

ISO 105 C08:2010 B2S GRADE

Solidez a la luz / Light fastness: 4

Solidez al frote húmedo / Rubbing fastness: 4-5

ISO 105 C06:2010 B2S GRADE

Solidez al lavado / Washing fastness: 4

ISO 3759:2011, ISO 6330:212 (5N TUMBLE DRY)

ISO 5077:2007 GRADE

Serie A

Levante



TURQUESA



GRIS



NARANJA



CHOCOLATE



AZUL



BEIGE



AMARILLO

Composición / Composition:

30% Poliéster 70% Algodón

Peso / Weight: 238 gr/ml

Ancho / Width: 280 cm.