

# Fabricamos para ti

*La vida es como andar en bicicleta,  
para conservar el equilibrio  
debes mantenerte en movimiento.*

*Albert Einstein*

*Sólo la experiencia adquirida duran-  
te estos 38 años, nos ha proporci-  
onado las herramientas necesarias  
para conseguir posicionar nuestra  
empresa como marca  
de referencia en el mercado.*

*En nuestras instalaciones  
de 6.500 m<sup>2</sup>, se fabrican  
íntegramente cada uno de nuestros  
modelos, consiguiendo así poder  
supervisar todos los procesos de  
trabajo a través de nuestro  
departamento de calidad.*

*Sólo seleccionando las mejores  
materias primas de proveedores  
nacionales y a través de la espe-  
cialización de nuestro personal con  
dos líneas de producción separadas  
(metal y madera), se consigue un  
alto nivel de satisfacción de nues-  
tros clientes que año tras año han  
confiado en nosotros.*

## *English*

*Life is like riding a bicycle.  
To keep your balance  
you must keep moving.*

*Albert Einstein*

*Only the experience gained during  
these 38 years has provided us the  
tools to get position our company as a  
leading brand in the market tools.*

*At our facilities 6,500 m<sup>2</sup>, is entirely  
made each of our models and getting  
to monitor all work processes through  
our quality department.*

*Selecting only the best raw materials  
from domestic suppliers and through  
the expertise of our staff with two  
separate production lines (metal and  
wood), a high level of customer satis-  
faction that is achieved year after year  
have trusted us.*

## *Français*

*La vie est comme faire du vélo.  
pour garder votre équilibre,  
vous devez continuer à avancer.*

*Albert Einstein*

*Nos 38 années d'expérience nous ont  
fournis le nécessaire pour positionner notre  
entreprise comme un référentiel de notre  
secteur sur le marché.*

*La totale fabrication de chacun de nos mo-  
dèles dans nos installations de 6.500 m<sup>2</sup>,  
permet que notre département de qualité  
puisse contrôler entièrement le processus  
de fabrication.*

*La sélection des meilleures matières pre-  
mières de nos fournisseurs nationaux, et  
la spécialisation de notre personnel avec  
deux lignes de fabrication (métal et bois),  
nous permet d'obtenir une grande satisfac-  
tion de nos clients qui nous font confiance  
depuis des années.*



# Tivoli

Chaiselongue

Tapizados disponibles  
serie H y M



# Tivoli

Tapizados disponibles  
serie H y M

Chaiselongue

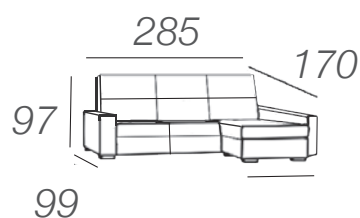

Ancho: 285 CM  
Fondo chaise: 170 CM  
Alto: 97 CM  
Fondo: 99 CM



CABEZALES RECLINABLES

ASIENTOS DESLIZANTES

ARCÓN



**Estructura de madera forrada en napa y goma.**

Wooden frame covered with imitation leather and foam.  
Structure en bois recouvert en napée et mousse.



**Respaldos reclinables con fibra hueca y goma picada.**

Reclining backrest with hollow fibre and chopped foam.  
Dossier inclinable garni de fibre creuse et piquage de mousse.



**Asiento extraíble regulable.**

Adjustable pull-out seat.  
Siège coulissant réglable.



**Brazos, asientos y respaldos desfundables.**

Removable covers on armrest, seats and backrest.  
Acoudoirs, sièges et dossiers déhoussables.



**Espuma de poliuretano de alta densidad HR más fibra.**

30 kg high-density polyurethane foam HR plus fiber.  
Mousse polyuréthane haute densité 30 kg/m<sup>3</sup>. HR + fibres.



**Fibra hueca de alta calidad siliconada.**

High quality silicone hollow fibre.  
Fibres creuses en silicone de haute qualité.



**Patas de metal.**

Metal legs.  
Pieds en metal.



**Materiales de primera calidad.**

Premium quality materials.  
Materiaux de première qualité.



**Fabricado con materiales reciclables.**

Manufactured with recyclable materials.  
Fabriqué en matériaux recyclable.

# Boston

Chaiselongue

Tapizados disponibles  
serie H y M



# Boston

Tapizados disponibles  
serie H y M

Chaiselongue

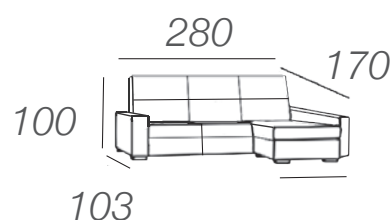

Ancho: 280 CM  
Fondo chaise: 170 CM  
Alto: 100 CM  
Fondo: 103 CM



CABEZALES RECLINABLES

ASIENTOS DESLIZANTES



**Estructura de madera forrada en napa y goma.**

Wooden frame covered with imitation leather and foam.  
Structure en bois recouvert en napée et mousse.



**Respaldos reclinables con fibra hueca y goma picada.**

Reclining backrest with hollow fibre and chopped foam.  
Dossier inclinable garni de fibre creuse et piquage de mousse.



**Asiento extraíble regulable.**

Adjustable pull-out seat.  
Siège coulissant réglable.



**Patas de metal.**

Metal legs.  
Pieds en metal.



**Brazos, asientos y respaldos desenfundables.**

Removable covers on armrest, seats and backrest.  
Acoudoirs, sièges et dossiers déhoussables.



**Espuma de poliuretano de alta densidad HR 30 kg/m<sup>3</sup> más fibra.**

30 kg/m<sup>3</sup> high-density polyurethane foam HR plus fiber.  
Mousse polyuréthane haute densité 30 kg/m<sup>3</sup>. HR + fibres.



**Fibra hueca de alta calidad siliconada.**

High quality silicone hollow fibre.  
Fibres creuses en silicone de haute qualité.



**Materiales de primera calidad.**

Premium quality materials.  
Materiaux de première qualité.



**Fabricado con materiales reciclables.**

Manufactured with recyclable materials.  
Fabriqué en matériaux recyclable.



**4 cm de visco elástica en los asientos.**

Seats with 4 cm memory foam.  
4 cm viscoelastique en sièges.



**Ideal para robot aspirador.**

Ideal for vacuum robot.  
Idéal pour le aspirateur robot.

# Noa

Chaiselongue

Tapizados disponibles  
serie H y M



# Noa

## Chaiselongue

Tapizados disponibles  
serie H y M

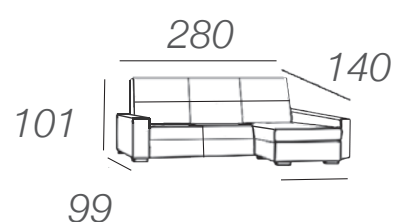

Ancho: 280 CM  
Fondo chaise: 140 CM  
Alto: 101 CM  
Fondo: 99 CM



MEDIDA CAMA ABIERTA INTERIOR 90x217 cm

CABEZALES RECLINABLES

ASIENTOS DESLIZANTES LARGOS

ARCÓN

CHAISELONGUE REVERSIBLE



**Estructura de madera forrada en napa y goma.**

Wooden frame covered with imitation leather and foam.  
Structure en bois recouvert en napée et mousse.



**Respaldos reclinables con fibra hueca y goma picada.**

Reclining backrest with hollow fibre and chopped foam.  
Dossier inclinable garni de fibre creuse et piquage de mousse.



**Asiento extraíble regulable.**

Adjustable pull-out seat.  
Siège coulissant réglable.



**Brazos, asientos y respaldos desfundables.**

Removable covers on armrest, seats and backrest.  
Acoudoirs, sièges et dossiers déhoussables.



**Espuma de poliuretano de alta densidad HR 28kg/m<sup>3</sup> más fibra.**

28 kg high-density polyurethane foam HR plus fiber.  
Mousse polyuréthane haute densité 28 kg/m<sup>3</sup>. HR + fibres.



**Fibra hueca de alta calidad siliconada.**

High quality silicone hollow fibre.  
Fibres creuses en silicone de haute qualité.



**Patas de metal.**

Metal legs.  
Pieds en metal.



**Materiales de primera calidad.**

Premium quality materials.  
Materiaux de première qualité.



**Fabricado con materiales reciclables.**

Manufactured with recyclable materials.  
Fabriqué en matériaux recyclable.

# Noa

Sofá 3p deslizable

Tapizados disponibles  
serie H y M





# Noa

## Sofá 3p deslizante

Tapizados disponibles  
serie H y M

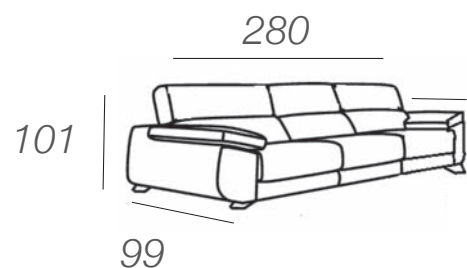

Ancho: 280 CM  
Alto: 101 CM  
Fondo: 99 CM



MEDIDA CAMA ABIERTA INTERIOR 90x217 cm

CABEZALES RECLINABLES

ASIENTOS DESLIZANTES LARGOS



**Estructura de madera forrada en napa y goma.**

Wooden frame covered with imitation leather and foam.  
Structure en bois recouvert en napée et mousse.



**Respaldos reclinables con fibra hueca y goma picada.**

Reclining backrest with hollow fibre and chopped foam.  
Dossier inclinable garni de fibre creuse et piquage de mousse.



**Asiento extraíble regulable.**

Adjustable pull-out seat.  
Siège coulissant réglable.



**Brazos, asientos y respaldos desenfundables.**

Removable covers on armrest, seats and backrest.  
Acoudoirs, sièges et dossiers déhoussables.



**Espuma de poliuretano de alta densidad HR 28kg/m<sup>3</sup> más fibra.**

28 kg high-density polyurethane foam HR plus fiber.  
Mousse polyuréthane haute densité 28 kg/m<sup>3</sup>. HR + fibres.



**Fibra hueca de alta calidad siliconada.**

High quality silicone hollow fibre.  
Fibres creuses en silicone de haute qualité.



**Patas de metal.**

Metal legs.  
Pieds en metal.



**Materiales de primera calidad.**

Premium quality materials.  
Materiaux de première qualité.



**Fabricado con materiales reciclables.**

Manufactured with recyclable materials.  
Fabriqué en matériaux recyclable.

# Capri

Chaiselongue

Tapizados disponibles  
serie H y M



# Capri

## Chaiselongue

Tapizados disponibles  
serie H y M

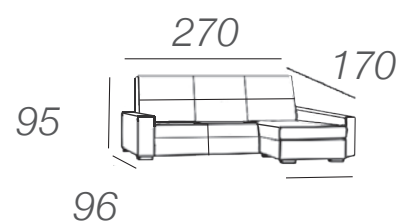

Ancho: 270 CM  
Fondo chaise: 170 CM  
Alto: 95 CM  
Fondo: 96 CM



CABEZALES RECLINABLES

ASIENTOS DESLIZANTES

ARCÓN

2 POUFS



**Estructura de madera forrada en napa y goma.**

Wooden frame covered with imitation leather and foam.  
Structure en bois recouvert en napée et mousse.



**Respaldos reclinables con fibra hueca y goma picada.**

Reclining backrest with hollow fibre and chopped foam.  
Dossier inclinable garni de fibre creuse et piquage de mousse.



**Asiento extraíble regulable.**

Adjustable pull-out seat.  
Siège coulissant réglable.



**Brazos, asientos y respaldos desenfundables.**

Removable covers on armrest, seats and backrest.  
Acoudoirs, sièges et dossiers déhoussables.



**Espuma de poliuretano de alta densidad HR 28kg/m3 más fibra.**

28 kg high-density polyurethane foam HR plus fiber.  
Mousse polyuréthane haute densité 28 kg/m<sup>3</sup>. HR + fibres.



**Fibra hueca de alta calidad siliconada.**

High quality silicone hollow fibre.  
Fibres creuses en silicone de haute qualité.



**Patas de metal.**

Metal legs.  
Pieds en metal.



**Materiales de primera calidad.**

Premium quality materials.  
Matériaux de première qualité.



**Fabricado con materiales reciclables.**

Manufactured with recyclable materials.  
Fabriqué en matériaux recyclable.

# Sofia

Chaiselongue

Tapizados disponibles  
serie H y M



# Sofía

## Chaiselongue

Tapizados disponibles  
serie H y M

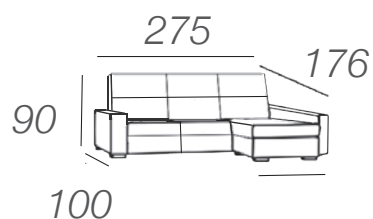

Ancho: 275 CM  
Fondo chaise: 176 CM  
Alto: 90 CM  
Fondo: 100 CM



### Estructura de madera forrada en napa y goma.

Wooden frame covered with imitation leather and foam.  
Structure en bois recouvert en nappée et mousse.



### 4 cm de visco elástica en los asientos.

Seats with 4 cm memory foam.  
4 cm viscoelastique en sièges.



### Cojines decorativos, asientos y respaldos desenfundables.

Removable covers on decorative pillows, seats and backrest.  
Coussins décoratifs, sièges et dossiers déhoussables.



### Espuma de poliuretano de alta densidad HR 30 kg/m<sup>3</sup> más fibra.

30 kg/m<sup>3</sup> high-density polyurethane foam HR plus fiber.  
Mousse polyuréthane haute densité 30 kg/m<sup>3</sup>. HR + fibres.



### Fibra hueca de alta calidad siliconada.

High quality silicone hollow fiber.  
Fibres creuses en silicone de haute qualité.



### Patas de madera.

Wooden legs.  
Pieds en bois.



### Materiales de primera calidad.

Premium quality materials.  
Matériaux de première qualité.



### Fabricado con materiales reciclables.

Manufactured with recyclable materials.  
Fabriqué en matériaux recyclable.



### Ideal para robot aspirador.

Ideal for vacuum robot.  
Idéal pour le aspirateur robot.

# Nadot

Chaiselongue

Tapizados disponibles  
serie H y M



# Nadot

Tapizados disponibles  
serie H y M

Chaiselongue

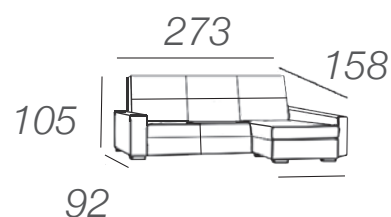

Ancho: 273 CM  
Fondo chaise: 158 CM  
Alto: 105 CM  
Fondo: 92 CM



## ASIENTOS DESLIZANTES



### Estructura de madera forrada en napa y goma.

Wooden frame covered with imitation leather and foam.  
Structure en bois recouvert en nappée et mousse.



### Asiento extraíble regulable.

Adjustable pull-out seat.  
Siège coulissant réglable.



### Brazos, asientos y respaldos desenfundables.

Removable covers on armrest, seats and backrest.  
Acoudoirs, sièges et dossiers déhoussables.



### Espuma de poliuretano de alta densidad HR 28 kg/m<sup>3</sup> más fibra.

28 kg/m<sup>3</sup> high-density polyurethane foam HR plus fiber.  
Mousse polyuréthane haute densité 28 kg/m<sup>3</sup>. HR + fibres.



### Fibra hueca de alta calidad siliconada.

High quality silicone hollow fiber.  
Fibres creuses en silicone de haute qualité.



### Patas de metal.

Metal legs.  
Pieds en metal.



### Materiales de primera calidad.

Premium quality materials.  
Matériaux de première qualité.



### Fabricado con materiales reciclables.

Manufactured with recyclable materials.  
Fabriqué en matériaux recyclables.



### Ideal para robot aspirador.

Ideal for vacuum robot.  
Idéal pour le aspirateur robot.

# Nadot

Sofá 2 y 3 plazas

Tapizados disponibles  
serie H y M





# Nadot

Sofá

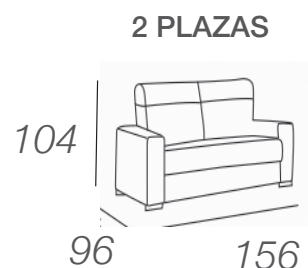
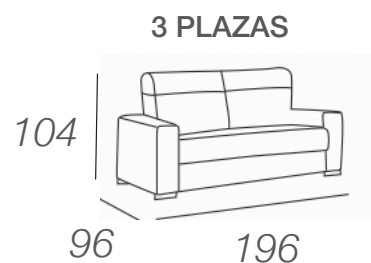

Ancho: 196 CM  
Fondo: 96 CM  
Alto: 104 CM

Ancho: 156 CM  
Fondo: 96 CM  
Alto: 104 CM



## ASIENTOS DESLIZANTES



### Estructura de madera forrada en napa y goma.

Wooden frame covered with imitation leather and foam.  
Structure en bois recouvert en nappée et mousse.



### Asiento extraíble regulable.

Adjustable pull-out seat.  
Siège coulissant réglable.



### Brazos, asientos y respaldos desenfundables.

Removable covers on armrest, seats and backrest.  
Acoudoirs, sièges et dossiers déhoussables.



### Espuma de poliuretano de alta densidad HR 28 kg/m<sup>3</sup> más fibra.

28 kg/m<sup>3</sup> high-density polyurethane foam HR plus fiber.  
Mousse polyuréthane haute densité 28 kg/m<sup>3</sup>. HR + fibres.



### Fibra hueca de alta calidad siliconada.

High quality silicone hollow fiber.  
Fibres creuses en silicone de haute qualité.



### Patas de metal.

Metal legs.  
Pieds en metal.



### Materiales de primera calidad.

Premium quality materials.  
Matériaux de première qualité.



### Fabricado con materiales reciclables.

Manufactured with recyclable materials.  
Fabriqué en matériaux recyclables.



### Ideal para robot aspirador.

Ideal for vacuum robot.  
Idéal pour le aspirateur robot.

# Aitana

Chaise longue

Tapizados disponibles  
serie H y M

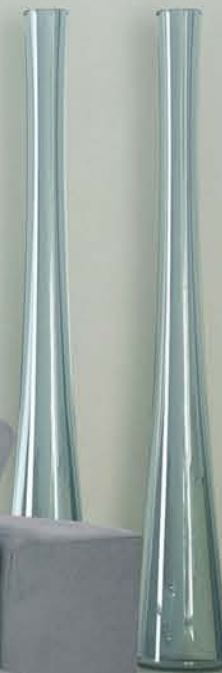

# Aitana

## Chaiselongue

Tapizados disponibles  
serie H y M

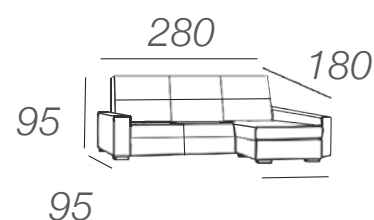

Ancho: 280 CM  
Fondo chaise: 180 CM  
Alto: 95 CM  
Fondo: 95 CM



CABEZALES RECLINABLES

ASIENTOS DESLIZANTES

CHAISELONGUE REVERSIBLE

4 POUFS



**Estructura de madera forrada en napa y goma.**

Wooden frame covered with imitation leather and foam.  
Structure en bois recouvert en nappée et mousse.



**Respaldos reclinables con fibra hueca y goma picada.**

Reclining backrest with hollow fibre and chopped foam.  
Dossier inclinable garni de fibre creuse et piquage de mousse.



**Asiento extraíble regulable.**

Adjustable pull-out seat.  
Siège coulissant réglable.



**Brazos, asientos y respaldos desenfundables.**

Removable covers on armrest, seats and backrest.  
Acoudoirs, sièges et dossiers déhoussables.



**Espuma de poliuretano de alta densidad HR 28 kg/m<sup>3</sup> más fibra.**

28 kg/m<sup>3</sup> high-density polyurethane foam HR plus fiber.  
Mousse polyuréthane haute densité 28 kg/m<sup>3</sup>. HR + fibres.



**Fibra hueca de alta calidad siliconada.**

High quality silicone hollow fibre.  
Fibres creuses en silicone de haute qualité.



**Patas de metal.**

Metal legs.  
Pieds en metal.



**Materiales de primera calidad.**

Premium quality materials.  
Materiaux de première qualité.



**Fabricado con materiales reciclables.**

Manufactured with recyclable materials.  
Fabriqué en matériaux recyclable.

# Lyon

Chaiselongue

Tapizados disponibles  
serie H y M



# Lyon

## Chaiselongue

Tapizados disponibles  
serie H y M

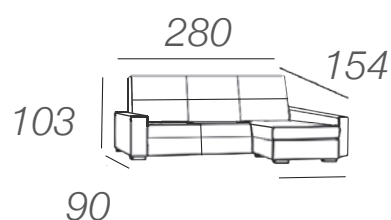

Ancho: 280 CM  
Fondo chaise: 154 CM  
Alto: 103 CM  
Fondo: 90 CM



CABEZALES RECLINABLES

ASIENTOS DESLIZANTES

ARCÓN



**Estructura de madera forrada en napa y goma.**

Wooden frame covered with imitation leather and foam.  
Structure en bois recouvert en nappée et mousse.



**Respaldos reclinables con fibra hueca y goma picada.**

Reclining backrest with hollow fibre and chopped foam.  
Dossier inclinable garni de fibre creuse et piquage de mousse.



**Asiento extraíble regulable.**

Adjustable pull-out seat.  
Siège coulissant réglable.



**Brazos, asientos y respaldos desenfundables.**

Removable covers on armrest, seats and backrest.  
Acoudoirs, sièges et dossiers déhoussables.



**Espuma de poliuretano de alta densidad HR 28kg/m<sup>3</sup> más fibra.**

28 kg high-density polyurethane foam HR plus fiber.  
Mousse polyuréthane haute densité 28 kg/m<sup>3</sup>, HR + fibres.



**Fibra hueca de alta calidad siliconada.**

High quality silicone hollow fibre.  
Fibres creuses en silicone de haute qualité.



**Patas de metal.**

Metal legs.  
Pieds en metal.



**Materiales de primera calidad.**

Premium quality materials.  
Materiaux de première qualité.



**Fabricado con materiales reciclables.**

Manufactured with recyclable materials.  
Fabriqué en matériaux recyclable.

# Lyon

Sofá 2 y 3 plazas

Tapizados disponibles  
serie H y M



# Lyon

Sofá

Tapizados disponibles  
serie H y M

3 PLAZAS

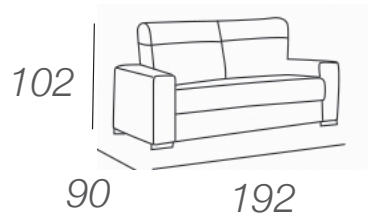

Ancho: 192 CM  
Fondo: 90 CM  
Alto: 102 CM

2 PLAZAS

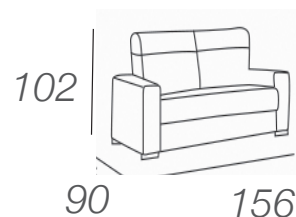

Ancho: 156 CM  
Fondo: 90 CM  
Alto: 102 CM



CABEZALES RECLINABLES

ASIENTOS DESLIZANTES



**Estructura de madera forrada en napa y goma.**

Wooden frame covered with imitation leather and foam.  
Structure en bois recouvert en nappée et mousse.



**Respaldos reclinables con fibra hueca y goma picada.**

Reclining backrest with hollow fibre and chopped foam.  
Dossier inclinable garni de fibre creuse et piquage de mousse.



**Asiento extraíble regulable.**

Adjustable pull-out seat.  
Siège coulissant réglable.



**Brazos, asientos y respaldos desenfundables.**

Removable covers on armrest, seats and backrest.  
Acoudoirs, sièges et dossiers déhoussables.



**Espuma de poliuretano de alta densidad HR 28kg/m<sup>3</sup> más fibra.**

28 kg high-density polyurethane foam HR plus fiber.  
Mousse polyuréthane haute densité 28 kg/m<sup>3</sup>. HR + fibres.



**Fibra hueca de alta calidad siliconada.**

High quality silicone hollow fibre.  
Fibres creuses en silicone de haute qualité.



**Patas de metal.**

Metal legs.  
Pieds en metal.



**Materiales de primera calidad.**

Premium quality materials.  
Materiaux de première qualité.



**Fabricado con materiales reciclables.**

Manufactured with recyclable materials.  
Fabriqué en matériaux recyclable.

# Modena

Chaiselongue con 2 poufs

Tapizados disponibles  
serie H y M





# Modena

## Chaiselongue con 2 poufs

Tapizados disponibles  
serie H y M

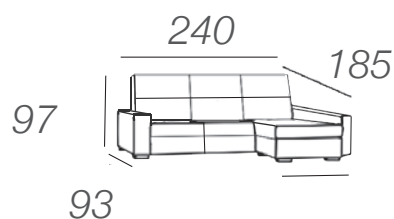

Ancho: 240 CM  
Fondo chaise: 185 CM  
Alto: 97 CM  
Fondo: 93 CM



CABEZALES RECLINABLES

ASIENTOS DESLIZANTES

POUF REVERSIBLE

POSIBILIDAD DE 2 POUFS



**Estructura de madera forrada en napa y goma.**

Wooden frame covered with imitation leather and foam.  
Structure en bois recouvert en nappée et mousse.



**Respaldos reclinables con fibra hueca y goma picada.**

Reclining backrest with hollow fibre and chopped foam.  
Dossier inclinable garni de fibre creuse et piquage de mousse.



**Asiento extraíble regulable.**

Adjustable pull-out seat.  
Siège coulissant réglable.



**Brazos, asientos y respaldos desenfundables.**

Removable covers on armrest, seats and backrest.  
Acoudoirs, sièges et dossiers déhoussables.



**Espuma de poliuretano de alta densidad HR 28kg/m<sup>3</sup> más fibra.**

28 kg high-density polyurethane foam HR plus fiber.  
Mousse polyuréthane haute densité 28 kg/m<sup>3</sup>. HR + fibres.



**Fibra hueca de alta calidad siliconada.**

High quality silicone hollow fibre.  
Fibres creuses en silicone de haute qualité.



**Patas de PVC.**

PVC legs.  
Pieds de PVC.



**Materiales de primera calidad.**

Premium quality materials.  
Matériaux de première qualité.



**Fabricado con materiales reciclables.**

Manufactured with recyclable materials.  
Fabriqué en matériaux recyclable.

*Iris*  
Chaiselongue  
Tapizados disponibles  
serie H y M



# Iris

## Chaiselongue brazo corto/brazo largo

Tapizados disponibles  
serie H y M

### BRAZO CORTO

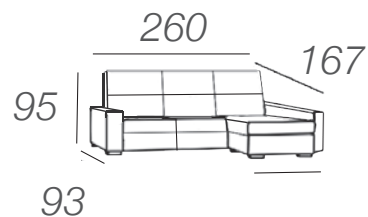

Ancho: 260 CM  
Fondo chaise: 167 CM  
Alto: 95 CM  
Fondo: 93 CM



CABEZALES RECLINABLES

ASIENTOS DESLIZANTES

ARCÓN

2 POUFS

BRAZO CORTO ES REVERSIBLE

### BRAZO LARGO

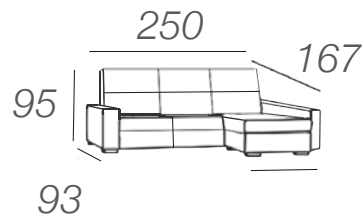

Ancho: 250 CM  
Fondo chaise: 167 CM  
Alto: 95 CM  
Fondo: 93 CM



**Estructura de madera forrada en napa y goma.**

Wooden frame covered with imitation leather and foam.  
Structure en bois recouvert en napée et mousse.



**Respaldos reclinables con fibra hueca y goma picada.**

Reclining backrest with hollow fibre and chopped foam.  
Dossier inclinable garni de fibre creuse et piquage de mousse.



**Asiento extraíble regulable.**

Adjustable pull-out seat.  
Siège coulissant réglable.



**Brazos, asientos y respaldos desenfundables.**

Removable covers on armrest, seats and backrest.  
Acoudoirs, sièges et dossiers déhoussables.



**Espuma de poliuretano de alta densidad HR 28kg/m3 más fibra.**

28 kg high-density polyurethane foam HR plus fiber.  
Mousse polyuréthane haute densité 28 kg/m<sup>3</sup>. HR + fibres.



**Fibra hueca de alta calidad siliconada.**

High quality silicone hollow fibre.  
Fibres creuses en silicone de haute qualité.



**Patas de metal.**

Metal legs.  
Pieds en metal.



**Materiales de primera calidad.**

Premium quality materials.  
Matériaux de première qualité.



**Fabricado con materiales reciclables.**

Manufactured with recyclable materials.  
Fabriqué en matériaux recyclable.

# Paris

Chaiselongue 3 plazas

Tapizados disponibles  
serie H y M



# Paris

## Chaiselongue 3 plazas fijo/deslizante

Tapizados disponibles  
serie H y M

ASIENTO DESLIZANTE O FIJO

CHAISELONGUE DESLIZANTE  
REVERSIBLE

SE FABRICA EN DOS MEDIDAS



CHAISELONGUE 3 PLAZAS

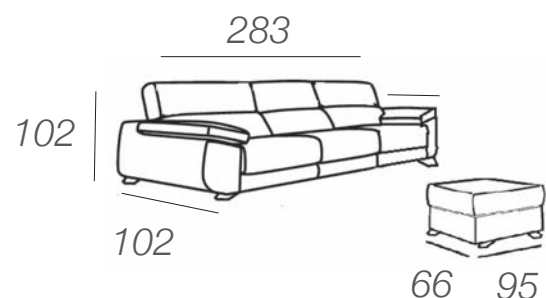

CHAISELONGUE 2 PLAZAS

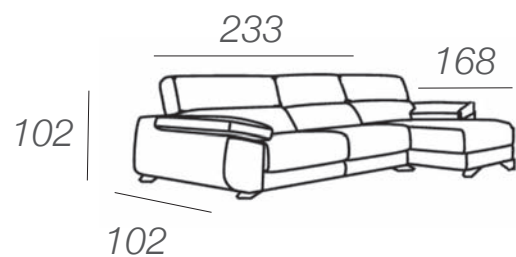
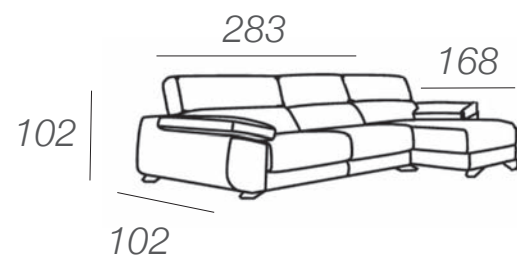
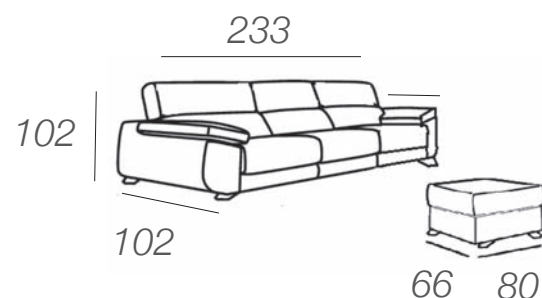

### Estructura de madera forrada en napa y goma.

Wooden frame covered with imitation leather and foam.  
Structure en bois recouvert en napée et mousse.



### Asiento extraíble regulable.

Adjustable pull-out seat.  
Siège coulissant réglable.



### Brazos, asientos y respaldos desenfundables.

Removable covers on armrest, seats and backrest.  
Acoudoirs, sièges et dossiers déhoussables.



### Espuma de poliuretano de alta densidad HR 28 kg/m<sup>3</sup> más fibra.

28 kg/m<sup>3</sup> high-density polyurethane foam HR plus fiber.  
Mousse polyuréthane haute densité 28 kg/m<sup>3</sup>. HR + fibres.



### Fibra hueca de alta calidad siliconada.

High quality silicone hollow fiber.  
Fibres creuses en silicone de haute qualité.



### Patas de metal.

Metal legs.  
Pieds en metal.



### Materiales de primera calidad.

Premium quality materials.  
Materiaux de première qualité.



### Fabricado con materiales reciclables.

Manufactured with recyclable materials.  
Fabriqué en matériaux recyclable.



### Ideal para robot aspirador.

Ideal for vacuum robot.  
Idéal pour le aspirateur robot.

# Paris

Sofá 3 + 2 plazas

Tapizados disponibles  
serie H y M



# Paris

## Sofá

Tapizados disponibles  
serie H y M

3 PLAZAS

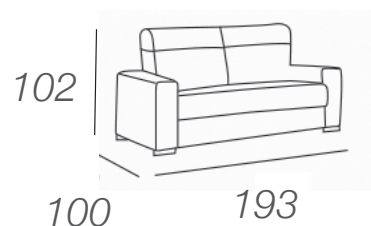

Ancho: 193 CM  
Alto: 102 CM  
Fondo: 100 CM

2 PLAZAS

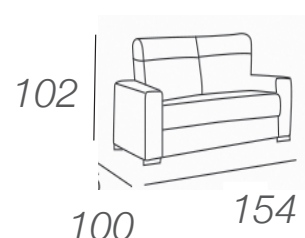

Ancho: 154 CM  
Fondo: 100 CM  
Alto: 102 CM



ASIENTOS DESLIZANTE O FIJO

RESPALDO RECLINABLE CON ASIENTOS DESLIZANTES



**Estructura de madera forrada en napa y goma.**

Wooden frame covered with imitation leather and foam.  
Structure en bois recouvert en nappée et mousse.



**Respaldos reclinables con fibra hueca y goma picada.**

Reclining backrest with hollow fibre and chopped foam.  
Dossier inclinable garni de fibre creuse et piquage de mousse.



**Asiento extraíble regulable.**

Adjustable pull-out seat.  
Siège coulissant réglable.



**Brazos, asientos y respaldos desenfundables.**

Removable covers on armrest, seats and backrest.  
Acoudoirs, sièges et dossiers déhoussables.



**Espuma de poliuretano de alta densidad HR 28kg/m<sup>3</sup> más fibra.**

28 kg high-density polyurethane foam HR plus fiber.  
Mousse polyuréthane haute densité 28 kg/m<sup>3</sup>. HR + fibres.



**Fibra hueca de alta calidad siliconada.**

High quality silicone hollow fibre.  
Fibres creuses en silicone de haute qualité.



**Patas de metal.**

Metal legs.  
Pieds en metal.



**Materiales de primera calidad.**

Premium quality materials.  
Matériaux de première qualité.



**Fabricado con materiales reciclables.**

Manufactured with recyclable materials.  
Fabriqué en matériaux recyclable.



**Ideal para robot aspirador.**

Ideal for vacuum robot.  
Idéal pour le aspirateur robot.

# Genova

Chaiselongue

Tapizados disponibles  
serie H y M





# Genova

## Chaiselongue

Tapizados disponibles  
serie H y M

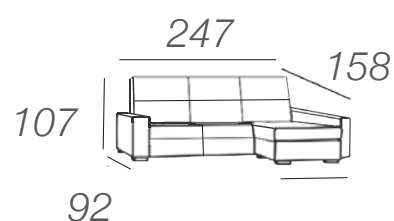

Ancho: 247 CM  
Fondo chaise: 158 CM  
Alto: 107 CM  
Fondo: 92 CM



### Estructura de madera forrada en napa y goma.

Wooden frame covered with imitation leather and foam.  
Structure en bois recouvert en nappée et mousse.



### Brazos, asientos y respaldos desenfundables.

Removable covers on armrest, seats and backrest.  
Acoudoirs, sièges et dossiers déhoussables.



### Espuma de poliuretano de alta densidad HR 25kg/m<sup>3</sup> más fibra.

25 kg high-density polyurethane foam HR plus fiber.  
Mousse polyuréthane haute densité 25 kg/m<sup>3</sup>. HR + fibres.



### Fibra hueca de alta calidad siliconada.

High quality silicone hollow fiber.  
Fibres creuses en silicone de haute qualité.



### Patas de madera.

Wooden legs.  
Pieds en bois.



### Materiales de primera calidad.

Premium quality materials.  
Matériaux de première qualité.



### Fabricado con materiales reciclables.

Manufactured with recyclable materials.  
Fabriqué en matériaux recyclables.



### Chaiselongue reversible.

Reversible corner sofa.  
Canapé d'angle réversible.

# Oporto

Sofá 3 + 2 plazas

Tapizados disponibles  
serie H y M



# Operto

## Sofá

Tapizados disponibles  
serie H y M

3 PLAZAS

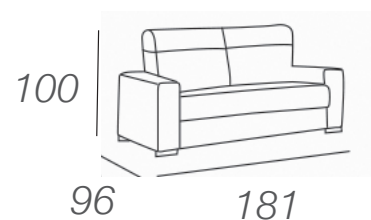

Ancho: 181 CM  
Fondo: 96 CM  
Alto: 100 CM

2 PLAZAS

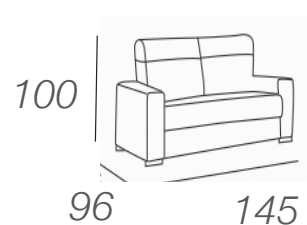

Ancho: 145 CM  
Fondo: 96 CM  
Alto: 100 CM



### Estructura de madera forrada en napa y goma.

Wooden frame covered with imitation leather and foam.  
Structure en bois recouvert en nappée et mousse.



### Brazos, asientos y respaldos desenfundables.

Removable covers on armrest, seats and backrest.  
Acoudoirs, sièges et dossiers déhoussables.



### Espuma de poliuretano de alta densidad HR 25kg/m<sup>3</sup> más fibra.

25 kg high-density polyurethane foam HR plus fiber.  
Mousse polyuréthane haute densité 25 kg/m<sup>3</sup>. HR + fibres.



### Fibra hueca de alta calidad siliconada.

High quality silicone hollow fiber.  
Fibres creuses en silicone de haute qualité.



### Patas de madera.

Wooden legs.  
Pieds en bois.



### Materiales de primera calidad.

Premium quality materials.  
Matériaux de première qualité.



### Fabricado con materiales reciclables.

Manufactured with recyclable materials.  
Fabriqué en matériaux recyclable.

# ivato

Sofá 3 plazas

Tapizados disponibles  
serie H y M



# Ívato

## Sofá

Tapizados disponibles  
serie H y M

### SOFÁ 3 PLAZAS

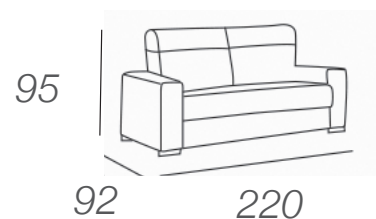

Ancho: 220 CM  
Fondo: 92 CM  
Alto: 95 CM



### ASIENTOS DESLIZANTES



#### Estructura de madera forrada en napa y goma.

Wooden frame covered with imitation leather and foam.  
Structure en bois recouvert en nappée et mousse.



#### Asiento extraíble regulable.

Adjustable pull-out seat.  
Siège coulissant réglable.



#### Brazos, asientos y respaldos desenfundables.

Removable covers on armrest, seats and backrest.  
Accoudoirs, sièges et dossiers déhoussables.



#### Espuma de poliuretano de alta densidad HR 28kg/m<sup>3</sup> más fibra.

28 kg high-density polyurethane foam HR plus fiber.  
Mousse polyuréthane haute densité 28 kg/m<sup>3</sup>. HR + fibres.



#### Fibra hueca de alta calidad siliconada.

High quality silicone hollow fiber.  
Fibres creuses en silicone de haute qualité.



#### Patas de metal.

Metal legs.  
Pieds en metal.



#### Materiales de primera calidad.

Premium quality materials.  
Matériaux de première qualité.



#### Fabricado con materiales reciclables.

Manufactured with recyclable materials.  
Fabriqué en matériaux recyclables.

# Landy

Chaiselongue

Tapizados disponibles  
serie H y M



# Landy

## Chaiselongue

Tapizados disponibles  
serie H y M

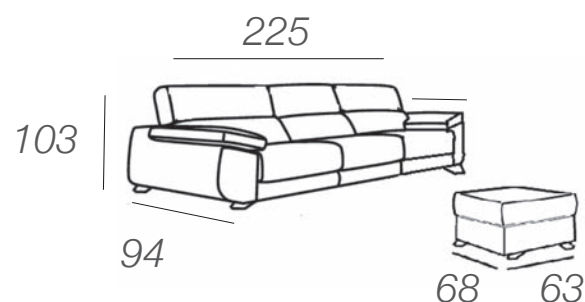

Ancho: 225 CM  
Fondo chaise: 162 CM  
Alto: 103 CM  
Fondo: 94 CM



### Estructura de madera forrada en napa y goma.

Wooden frame covered with imitation leather and foam.  
Structure en bois recouverte en nappée et mousse.



### Brazos, asientos y respaldos desfundables.

Removable covers on armrest, seats and backrest.  
Acoudoirs, sièges et dossiers déhoussables.



### Espuma de poliuretano de alta densidad HR 25kg/m<sup>3</sup> más fibra.

25 kg high-density polyurethane foam HR plus fiber.  
Mousse polyuréthane haute densité 25 kg/m<sup>3</sup>. HR + fibres.



### Fibra hueca de alta calidad siliconada.

High quality silicone hollow fiber.  
Fibres creuses en silicone de haute qualité.



### Patas de madera.

Wooden legs.  
Pieds en bois.



### Materiales de primera calidad.

Premium quality materials.  
Matériaux de première qualité.



### Fabricado con materiales reciclables.

Manufactured with recyclable materials.  
Fabriqué en matériaux recyclables.



### Chaiselongue reversible.

Reversible corner sofa.  
Canapé d'angle réversible.

# Landy

Sofá 3 + 2 plazas

Tapizados disponibles  
serie H y M





# Landy

Sofá

Tapizados disponibles  
serie H y M

3 PLAZAS

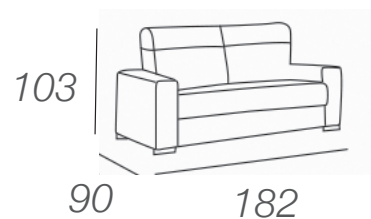

Ancho: 182 CM  
Fondo: 90 CM  
Alto: 103 CM

2 PLAZAS

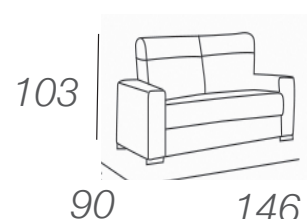

Ancho: 146 CM  
Fondo: 90 CM  
Alto: 103 CM



**Estructura de madera forrada en napa y goma.**

Wooden frame covered with imitation leather and foam.  
Structure en bois recouvert en napée et mousse.



**Brazos, asientos y respaldos desenfundables.**

Removable covers on armrest, seats and backrest.  
Acoudoirs, sièges et dossiers déhoussables.



**Espuma de poliuretano de alta densidad HR 25kg/m<sup>3</sup> más fibra.**

25 kg high-density polyurethane foam HR plus fiber.  
Mousse polyuréthane haute densité 25 kg/m<sup>3</sup>. HR + fibres.



**Fibra hueca de alta calidad siliconada.**

High quality silicone hollow fiber.  
Fibres creuses en silicone de haute qualité.



**Patas de madera.**

Wooden legs.  
Pieds en bois.



**Materiales de primera calidad.**

Premium quality materials.  
Matériaux de première qualité.



**Fabricado con materiales reciclables.**

Manufactured with recyclable materials.  
Fabriqué en matériaux recyclable.

# Maxi

## Chaiselongue

Tapizados disponibles  
serie H y M



# Maxi

## Chasielongue

Tapizados disponibles  
serie H y M

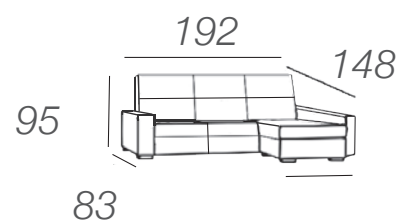

Ancho: 192 CM  
Fondo chaise: 148 CM  
Alto: 95 CM  
Fondo: 83 CM



### Estructura de madera forrada en napa y goma.

Wooden frame covered with imitation leather and foam.  
Structure en bois recouvert en napée et mousse.



### Brazos, asientos y respaldos desfundables.

Removable covers on armrest, seats and backrest.  
Acoudoirs, sièges et dossiers déhoussables.



### Espuma de poliuretano de alta densidad HR 23kg/m<sup>3</sup> más fibra.

23 kg high-density polyurethane foam HR plus fiber.  
Mousse polyuréthane haute densité 23 kg/m<sup>3</sup>. HR + fibres.



### Fibra hueca de alta calidad siliconada.

High quality silicone hollow fiber.  
Fibres creuses en silicone de haute qualité.



### Patas de PVC.

PVC legs.  
Pieds de PVC.



### Materiales de primera calidad.

Premium quality materials.  
Matériaux de première qualité.



### Fabricado con materiales reciclables.

Manufactured with recyclable materials.  
Fabriqué en matériaux recyclable.



### Chasielongue reversible.

Reversible corner sofa.  
Canapé d'angle réversible.

# Níxa

Sofá 3 + 2 plazas

Tapizados disponibles  
serie H y M



# Nixa

Sofá

Tapizados disponibles  
serie H y M

3 PLAZAS

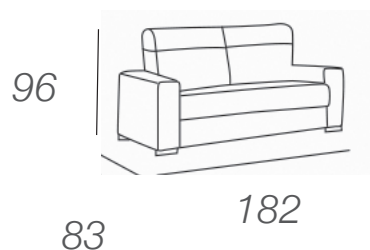

Ancho: 182 CM  
Fondo: 83 CM  
Alto: 96 CM

2 PLAZAS

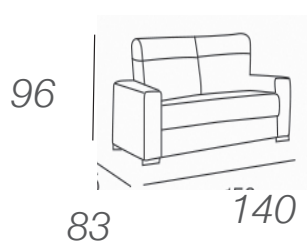

Ancho: 140 CM  
Fondo: 83 CM  
Alto: 96 CM



**Estructura de madera forrada en napa y goma.**

Wooden frame covered with imitation leather and foam.  
Structure en bois recouvert en nappée et mousse.



**Brazos, asientos y respaldos desfundables.**

Removable covers on armrest, seats and backrest.  
Acoudoirs, sièges et dossiers déhoussables.



**Espuma de poliuretano de alta densidad HR 23kg/m<sup>3</sup> más fibra.**

23 kg high-density polyurethane foam HR plus fiber.  
Mousse polyuréthane haute densité 23 kg/m<sup>3</sup>. HR + fibres.



**Fibra hueca de alta calidad siliconada.**

High quality silicone hollow fibre.  
Fibres creuses en silicone de haute qualité.



**2 patas delanteras de metal.**

2 front metal legs.  
2 pieds métalliques avant.



**PVC 2 patas traseras en PVC.**

2 PVC back legs.  
2 pieds arrière en PVC.



**Materiales de primera calidad.**

Premium quality materials.  
Matériaux de première qualité.



**Fabricado con materiales reciclables.**

Manufactured with recyclable materials.  
Fabriqué en matériaux recyclable.

# Milan

## Sofá-cama y Chaiselongue

Tapizados disponibles  
serie H y M



Brazo recto 17 cm. Brazo codera 21 cm.



# Milán

Sofá

Tapizados disponibles  
serie H y M

EL CHAISELONGUE MILAN SÓLO SE FABRICARÁ CON COLCHÓN DE 12 CM.



COLCHÓN 185 x 138 x 12 cm.  
COLCHÓN 185 x 138 x 16 cm.

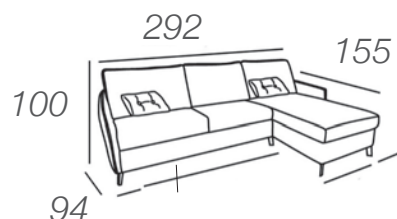

ANCHO BRAZO CODERA 300 CM

Ancho: 292 CM  
Fondo: 94 CM  
Alto: 100 CM  
Fondo chaise: 155 CM

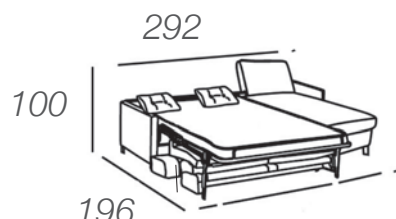

ANCHO BRAZO CODERA 300 CM

Ancho: 292 CM  
Fondo: 196 CM  
Alto: 100 CM

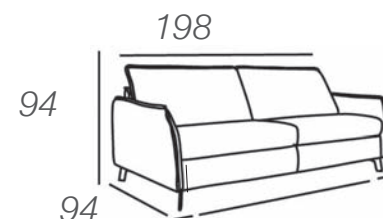

ANCHO BRAZO CODERA 204 CM

Ancho: 198 CM  
Fondo: 94 CM  
Alto: 94 CM

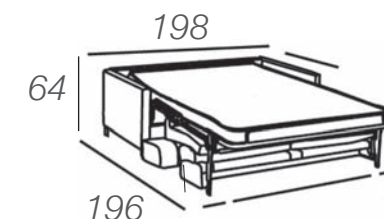

ANCHO BRAZO CODERA 204 CM

Ancho: 198 CM  
Fondo: 196 CM  
Alto: 64 CM



**Brazos de madera forrada en napa y goma.**

Wooden armrest covered with imitation leather and foam.  
Acoudoirs en bois recouvert en napée et mousse.



**Espuma de poliuretano de alta densidad HR 28kg/m<sup>3</sup> más fibra.**

28 kg high-density polyurethane foam HR plus fiber.  
Mousse polyuréthane haute densité 28 kg/m<sup>3</sup>. HR + fibres.



**Fabricado con materiales reciclables.**

Manufactured with recyclable materials.  
Fabriqué en matériaux recyclable.



**Mecanismo metálico con malla electrosoldada.**

Metallic mechanism with electrowelded mesh.  
Mecanisme metalique avec treillis électrosoudé.



**Fibra hueca de alta calidad siliconada.**

High quality silicone hollow fiber.  
Fibres creuses en silicone de haute qualité.



**Posibilidad de colchón en 12 o 16 cm. de grosor.**

Possibility of mattress in 12 or 16 cm thick.  
Possibilité de matelas en 12 ou 16 dm d'épaisseur.



**Brazos, asientos y respaldos desenfundables.**

Removable covers on armrest, seats and backrest.  
Acoudoirs, sièges et dossiers déhoussables.



**Patas de metal.**

Metal legs.  
Pieds en metal.



**Posibilidad de visco elástica en el colchón.**

Possibility of memory foam in the mattress.  
Possibilité de visco elastique dans le matelas.



**Materiales de primera calidad.**

Premium quality materials.  
Materiaux de première qualité.

# Praga

Sofá cama

Tapizados disponibles  
serie H y M





# Prague

Sofá

Tapizados disponibles  
serie H y M

EL CHAISELONGUE PRAGA  
SÓLO SE FABRICARÁ  
CON COLCHÓN DE 12 CM.

COLCHÓN 185 x 138 x 12 cm.  
COLCHÓN 185 x 138 x 16 cm.

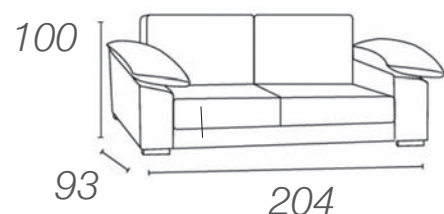

Ancho: 204CM  
Fondo: 93 CM  
Alto: 100 CM

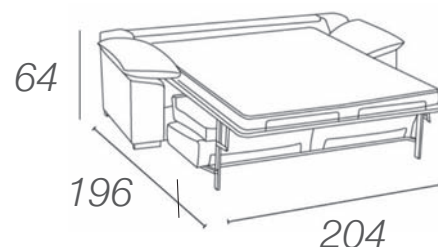

Ancho: 204 CM  
Fondo: 196 CM  
Alto: 64 CM

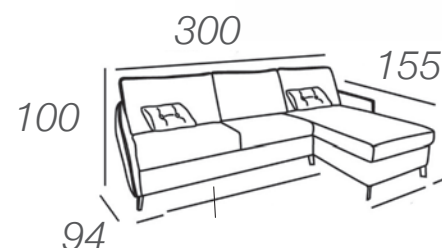

Ancho: 300 CM  
Fondo: 94 CM  
Alto: 100 CM  
Fondo chaise: 155 CM

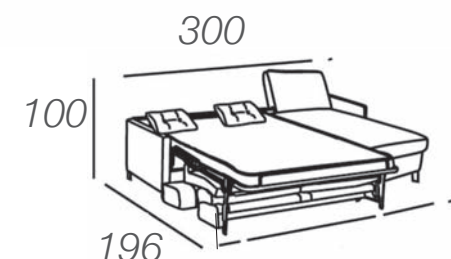

Ancho: 300 CM  
Fondo: 196 CM  
Alto: 100 CM



**Brazos de madera forrada en napa y goma.**

Wooden armrest covered with imitation leather and foam.  
Acoudoirs en bois recouvert en napée et mousse.



**Mecanismo metálico con malla electrosoldada.**

Metalic mechanism with electrowelded mesh.  
Mecanisme metalique avec treillis électrosoudé.



**Brazos, asientos y respaldos desenfundables.**

Removable covers on armrest, seats and backrest.  
Acoudoirs, sièges et dossiers déhoussables.



**Espuma de poliuretano de alta densidad HR 28kg/m<sup>3</sup> más fibra.**

28 kg high-density polyurethane foam HR plus fiber.  
Mousse polyuréthane haute densité 28 kg/m<sup>3</sup>. HR + fibres.



**Fibra hueca de alta calidad siliconada.**

High quality silicone hollow fibre.  
Fibres creuses en silicone de haute qualité.



**Patas de metal.**

Metal legs.  
Pieds en metal.



**Materiales de primera calidad.**

Premium quality materials.  
Materiaux de première qualité.



**Fabricado con materiales reciclables.**

Manufactured with recyclable materials.  
Fabriqué en matériaux recyclable.



**Posibilidad de colchón en 12 o 16 cm. de grosor.**

Possibility of mattress in 12 or 16 cm thick.  
Possibilité de matelas en 12 ou 16 dm d'épaisseur.



**Posibilidad de visco elástica en el colchón.**

Possibility of memory foam in the mattress.  
Possibilité de visco elastique dans le matelas.

# Corea

Sofá cama

Tapizados disponibles  
serie A y H (Junio, Zafiro y Cristal)



# Aris Atlas y Corea

## Sofá

Tapizados disponibles  
serie A y H (Junio, Zafiro y Cristal)

MEDIDA COLCHÓN GOMA 188x126x11,5  
MEDIDA COLCHÓN ARBOLAT 25 183x126x12  
MEDIDA COLCHÓN ARBOLAT 30 183x126x12

### SOFÁ CAMA COREA

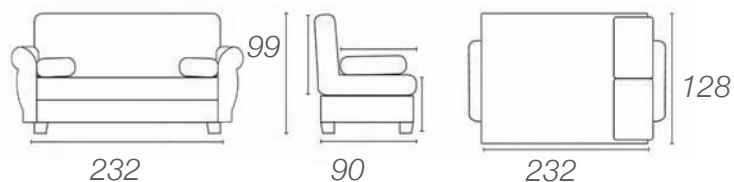

Ancho: 232 CM  
Fondo: 90 CM  
Alto: 99 CM

 **Sofá cama bisagra automática con dos posiciones.**  
Sofa bed with automatic hinge with two positions.  
Canapé-lit avec charnière automatique avec deux positions.

 **Brazos de madera forrada en napa y goma.**  
Wooden armrest covered with imitation leather and foam.  
Accoudoirs en bois recouvert en napée et mousse.

 **Edredón desenfundable.**  
Removable duvet.  
Housse déhoussable.

### SOFÁ CAMA COREA



**Patas de metal**

MEDIDA CAMA ABIERTA 232x128x44

### SOFÁ CAMA ATLAS



MEDIDA CAMA ABIERTA 225x128x44

LOS MODELOS COREA, ATLAS Y ARIS EN LAS TELAS LEVANTE, ZAFIRO Y JUNIO IRAN COMBINADAS CON ALBA CHOCO Y ALBA NEGRO EN LA BASE Y BRAZOS. SÓLO EN LA TELA CRISTAL SE PODRÁ FABRICAR TODO EN LA MISMA TELA

### SOFÁ CAMA ATLAS

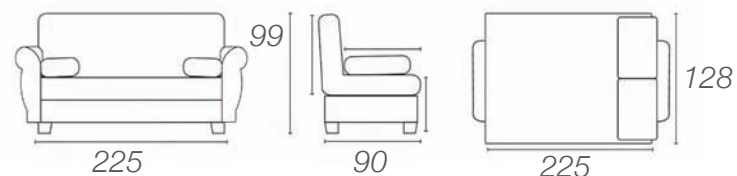

Ancho: 225 CM  
Fondo: 90 CM  
Alto: 99 CM

 **Bastidores metálicos con lamas de haya y eucalipto.**  
Metallic structure with beech and eucalyptus wood sheets.  
Armature métallique avec lattes en hêtre et eucalyptus.

 **Colchón goma, Arbolat 25 kg/m3 o Arbolat 30 kg/m3.**  
Foam mattress, Arbolat 25 kg/m3 or Arbolat 30 kg/m3.  
Matelas en mousse, Arbolat 25 kg/m3 ou Arbolat 30 kg/m3.

 **Fibra hueca de alta calidad siliconada.**  
High quality silicone hollow fibre.  
Fibres creuses en silicone de haute qualité.

### SOFÁ CAMA ARIS



MEDIDA CAMA ABIERTA 223x128x44

### SOFÁ CAMA ARIS

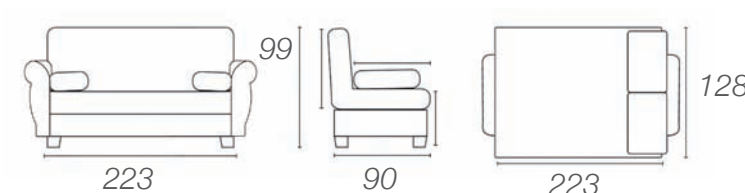

Ancho: 223 CM  
Fondo: 90 CM  
Alto: 99 CM

 **Patas de madera.**  
Wooden legs.  
Pieds en bois.

 **Base en tablero de partículas y madera forrada en napa tapizado.**  
Wooden base covered with imitation leather and upholstered.  
Base en panneaux de particules et en bois recouvert en napée et tapissé.

# Cenit S4 y S5

Sofá cama

Tapizados disponibles  
serie A y H (Junio, Zafiro y Cristal)



# Cenit

## Sofá

Tapizados disponibles  
serie A y H (Junio, Zafiro y Cristal)

SERIE 4 y 5



### SERIE 4 Y SERIE 5

COLCHÓN 190x127x17

CAMA ABIERTA 193x130x50

SERIE 5 COLCHÓN GOMA HR 30 KG/M3 + VISCO

SERIE 4 COLCHÓN GOMA HR 30 KG/M3

### SOFÁ CAMA CENIT SERIE 4 Y 5

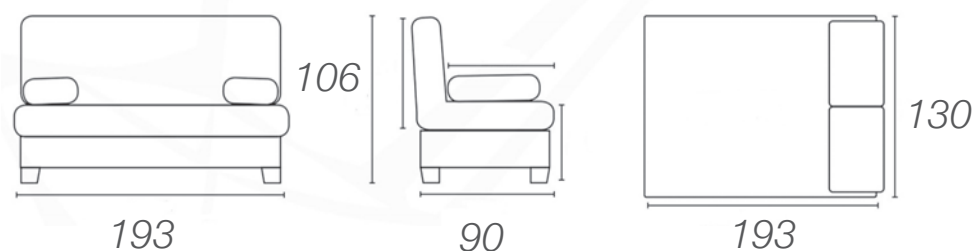

Ancho: 193 CM

Fondo: 90 CM

Alto: 106 CM



#### Sofá cama bisagra automática con dos posiciones.

Sofa bed with automatic hinge with two positions.

Canapé-lit avec charnière automatique avec deux positions.



#### Edredón desenfundable.

Removable duvet.

Housse déhoussable.



#### Bastidores metálicos con lamas de haya y eucalipto.

Metallic structure with beech and eucalyptus wood sheets.

Armature métallique avec lattes en hêtre et eucalyptus.



#### Colchón S4 unibloc 30 kg/m3, S5 unibloc 30 kg/m3 + visco.

Mattres S4 unibloc 30 kg/m3, S5 unibloc 30 kg/m3 + memory foam.

Matelas S4 unibloc 30 kg/m3, S5 unibloc 30 kg/m3 + visco elastique.



#### Fibra hueca de alta calidad siliconada.

High quality silicone hollow fibre.

Fibres creuses en silicone de haute qualité.



#### Patas de metal.

Metal legs.

Pieds en metal.



#### Base en tablero de partículas y madera forrada en napa tapizado.

Wooden base covered with imitation leather and upholstered.

Base en panneaux de particules et en bois recouvert en napée et tapissé.



#### Posibilidad de visco elástica en el colchón.

Possibility of memory foam in the mattress.

Possibilité de visco elastique dans le matelas.

# Cenit S3 y S2

Sofá cama

Tapizados disponibles  
serie A y H (Junio, Zafiro y Cristal)



# Cenit

## Sofá cama

Tapizados disponibles  
serie A y H (Junio, Zafiro y Cristal)

SERIE 1



SERIE 2 - SERIE 3



SERIE 1

SERIE 2 Y SERIE 3

COLCHÓN	188x126x11,5	COLCHÓN	188x126x12
CAMA ABIERTA	188x128x44	CAMA ABIERTA	188x128x47

SERIE 2: Colchón Arbolat 25

SERIE 3: Colchón Arbolat 30

SOFÁ CAMA CENIT SERIE 1

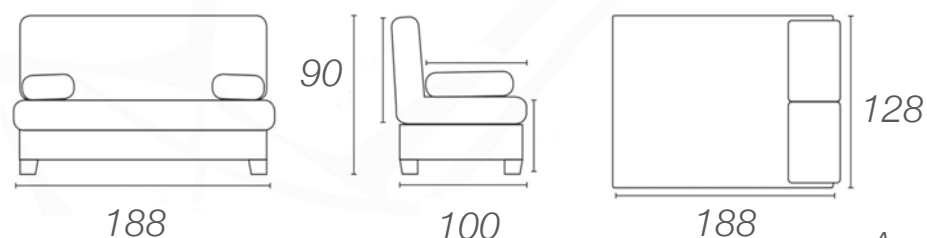

Ancho: 188 CM  
Fondo: 90 CM  
Alto: 100 CM

SOFÁ CAMA CENIT SERIE 2 Y SERIE 3

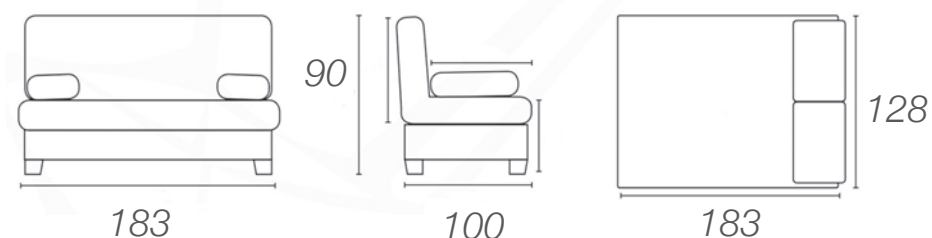

Ancho: 183 CM  
Fondo: 100 CM  
Alto: 90 CM



**Sofá cama bisagra automática con dos posiciones.**  
Sofa bed with automatic hinge with two positions.  
Canapé-lit avec charnière automatique avec deux positions.



**Edredón desenfundable.**  
Removable duvet.  
Housse déhoussable.



**Bastidores metálicos con lamas de haya y eucalipto.**  
Metallic structure with beech and eucalyptus wood sheets.  
Armature métallique avec lattes en hêtre et eucalyptus.



**Colchón goma, Arbolat 25 kg/m<sup>3</sup> o Arbolat 30 kg/m<sup>3</sup>.**  
Foam mattresses, Arbolat 25 kg/m<sup>3</sup> or Arbolat 30 kg/m<sup>3</sup>.  
Matelas en mousse, Arbolat 25 kg/m<sup>3</sup> ou Arbolat 30 kg/m<sup>3</sup>.



**Fibra hueca de alta calidad siliconada.**  
High quality silicone hollow fibre.  
Fibres creuses en silicone de haute qualité.



**Patas de metal. (SERIE 2 y 3)**  
Metal legs.  
Pieds en metal.



**PVC Patas de PVC. (SERIE 1)**  
PVC legs.  
Pieds en PVC.



**Base en tablero de partículas y madera forrada en napa tapizado.**  
Wooden base covered with imitation leather and upholstered.  
Base en panneaux de particules et en bois recouvert en napée et tapissé.

# Flandes

## Sofá cama

Tapizados disponibles  
serie A y H

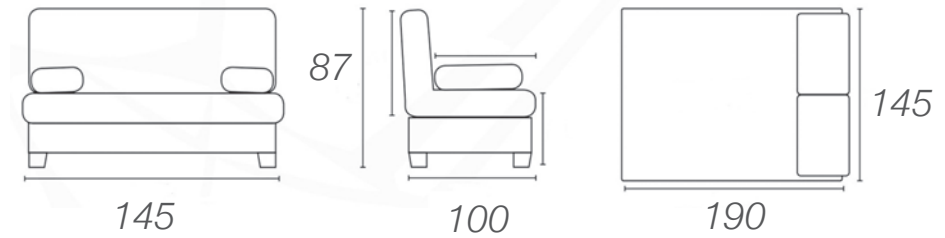

Ancho: 145 CM  
Fondo: 100 CM  
Alto: 87 CM

COCHÓN 190 X 140 X 12 CM



### Edredón desenfundable.

Removable duvet.  
Housse déhçussable.



### Colchón arbolat 25kg/m<sup>3</sup> o arbolat 30kg/m<sup>3</sup>.

Mattres arbolat 25kg/m<sup>3</sup> or arbolat 30kg/m<sup>3</sup>.  
Mattres arbolat 25kg/m<sup>3</sup> ou arbolat 30kg/m<sup>3</sup>.



### Fibra hueca de alta calidad siliconada.

High quality silicone hollow fibre.  
Fibres creuses en silicone de haute qualité.



### Estructura metálica con 16 lamas de haya.

Metalic frame with 16 beech wood sheets.  
Armature metalique avec 16 lattes en hêtre.



# Puf cama

Tapizados disponibles  
serie A

PUF CERRADO: 64 X 81 X 50 CM

PUF ABIERTO: 182 X 80 X 36 CM

COLCHÓN: 182 X 80 X 9 CM



**Edredón desenfundable.**

Removable duvet.  
Housse déhousable.



**Colchón goma HR.**

Foam mattress HR.  
Matelas en mousse HR.



**Fibra hueca de alta calidad siliconada.**

High quality silicone hollow fibre.  
Fibres creuses en silicone de haute qualité.



**Estructura metálica con lamas de haya y eucalipto.**

Metalic frame with beech and eucalyptus wood sheets.  
Armature metalique avec lattes en hêtre et eucalyptus.

# Nórdicos

Sofá 3+2 y butaca

Tapizados disponibles  
serie H y M



# Butacas

## Nórdicas

Tapizados disponibles  
serie H y M

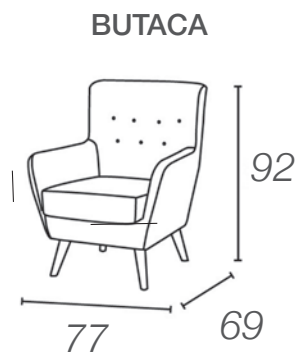

Medidas base  
Ancho: 77 CM  
Fondo: 69 CM  
Alto: 92 CM



2 PLAZAS

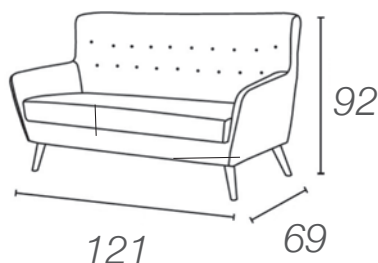

Medidas base  
Ancho: 121 CM  
Fondo: 69 CM  
Alto: 92 CM



3 PLAZAS

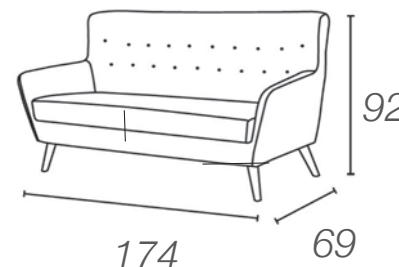

Medidas base  
Ancho: 174 CM  
Fondo: 69 CM  
Alto: 92 CM



### Estructura de madera forrada en napa y goma.

Wooden frame covered with imitation leather and foam.  
Structure en bois recouvert en napée et mousse.



### Espuma de poliuretano de alta densidad HR 25kg/m<sup>3</sup> más fibra.

25 kg high-density polyurethane foam HR plus fiber.  
Mousse polyuréthane haute densité 25 kg/m<sup>3</sup>. HR + fibres.



### Materiales de primera calidad.

Premium quality materials.  
Matériaux de première qualité.



### Asientos desenfundables.

Removable covers on seats.  
Sièges déhoussables.



### Fibra hueca de alta calidad siliconada.

High quality silicone hollow fiber.  
Fibres creuses en silicone de haute qualité.



### Fabricado con materiales reciclables.

Manufactured with recyclable materials.  
Fabriqué en matériaux recyclable.



### Patas de madera.

Wooden legs.  
Pieds en bois.

# Butacas

Tapizados disponibles  
serie H y M

Butaca fija y cunera



# Butacas

Tapizados disponibles  
serie H y M

BUTACA FIJA

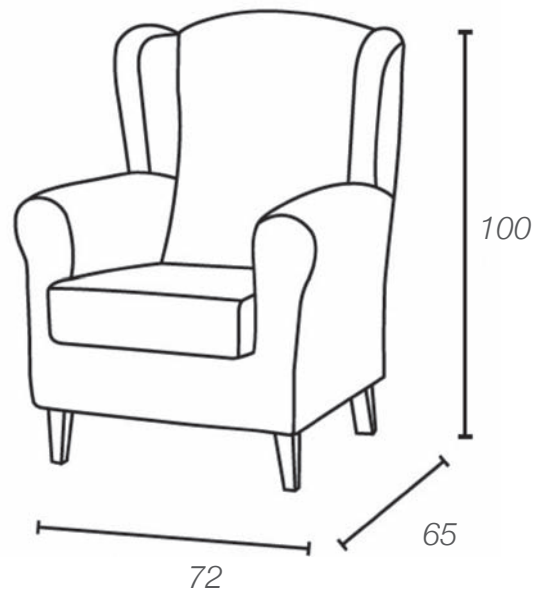

BUTACA CUNERA

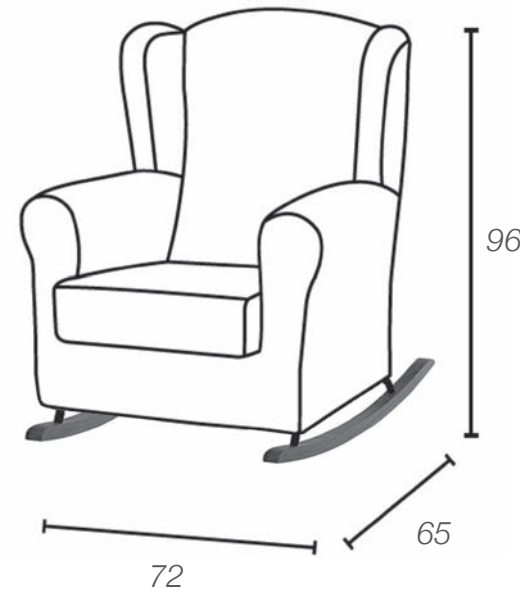

**Estructura de madera forrada en napa y goma.**

Wooden frame covered with imitation leather and foam.  
Structure en bois recouvert en napée et mousse.



**Espuma de poliuretano de alta densidad HR 25kg/m<sup>3</sup> más fibra.**

25 kg high-density polyurethane foam HR plus fiber.  
Mousse polyuréthane haute densité 25 kg/m<sup>3</sup>. HR + fibres.



**Materiales de primera calidad.**

Premium quality materials.  
Matériaux de première qualité.



**Asientos desenfundables.**

Removable covers on seats.  
Sièges déhoussables.



**Fibra hueca de alta calidad siliconada.**

High quality silicone hollow fiber.  
Fibres creuses en silicone de haute qualité.



**Fabricado con materiales reciclables.**

Manufactured with recyclable materials.  
Fabriqué en matériaux recyclable.



**Patas de madera.**

Wooden legs.  
Pieds en bois.

# Sillones Relax

Mecanismo  
de empuje y  
power lift

Tapizados disponibles  
serie H y M



# Sillones

Tapizados disponibles  
serie H y M

## RELAX CONFORT MECANISMO EMPUJE



Opción Power Lift

## RELAX OREJERO MECANISMO EMPUJE



SÓLO MECANISMO DE EMPUJE



### Estructura de madera forrada en napa y goma.

Wooden frame covered with imitation leather and foam.  
Structure en bois recouvert en nappée et mousse.



### Relax confort y respaldos desenfundables.

Removable covers on relax confort backrest.  
Relax confort dossiers déhoussables.



### Espuma de poliuretano de alta densidad HR 25kg/m<sup>3</sup> más fibra.

25 kg high-density polyurethane foam HR plus fiber.  
Mousse polyuréthane haute densité 25 kg/m<sup>3</sup>. HR + fibres.



### Fibra hueca de alta calidad siliconada.

High quality silicone hollow fiber.  
Fibres creuses en silicone de haute qualité.



### Patatas de PVC.

PVC legs.  
Pieds en PVC.



### Materiales de primera calidad.

Premium quality materials.  
Matériaux de première qualité.



### Fabricado con materiales reciclables.

Manufactured with recyclable materials.  
Fabriqué en matériaux recyclable.



### Mecanismo europeo de alta calidad.

High quality european mechanism.  
Mécanisme européen de haute qualité.

# *Cabeceiros*





# Cabeceiros

CABECERO CUADROS

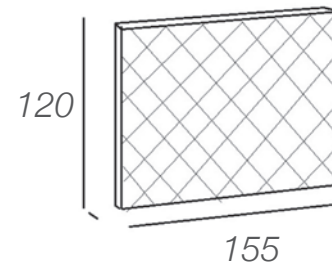
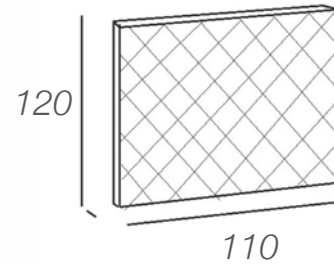

CABECERO ROMBOS



**Estructura de madera**

Wooden frame.  
Structure en bois.



**Fibra hueca de alta calidad siliconada.**

High quality silicone hollow fibre.  
Fibres creuses en silicone de haute qualité.



**Patatas de PVC.**

PVC legs.  
Pieds en PVC.



**Materiales de primera calidad.**

Premium quality materials.  
Materiaux de première qualité.



**Fabricado con materiales reciclables.**

Manufactured with recyclable materials.  
Fabriqué en matériaux recyclable.

# Serie M

*Magnolia*



CREMA



PIEDRA



PLOMO



CEMENTO



ROJO

Composición / Composition:

**100% Poliéster**

Peso / Weight: **340 gr/m<sup>2</sup>**

Ancho / Width: **140 cm.**

Resistencia a la abrasión / Abrasion resistance:

**>30.000 ciclos**

Solidez al frote / Rubbing fastness: **4-5**

ISO 105 C06:2010 B2S GRADE

Solidez a la luz / Light fastness: **3-4**

ISO 105 C06:2010 B2S GRADE

Solidez al lavado / Washing fastness: **3-4**

ISO 3759:2011, ISO 6330:212 (5N TUMBLE DRY)

ISO 5077:2007 GRADE

# Serie M

*Montero*

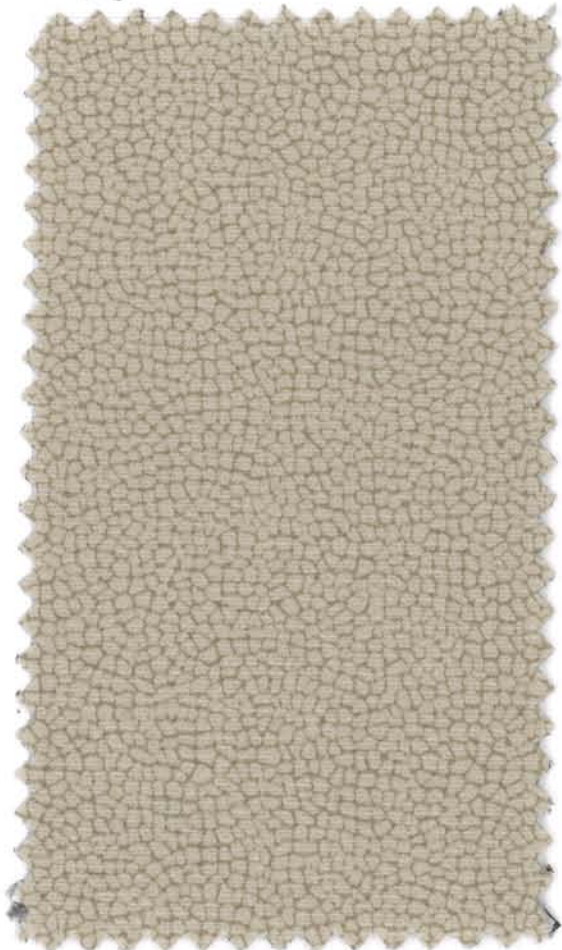

PIEDRA



CHOCO

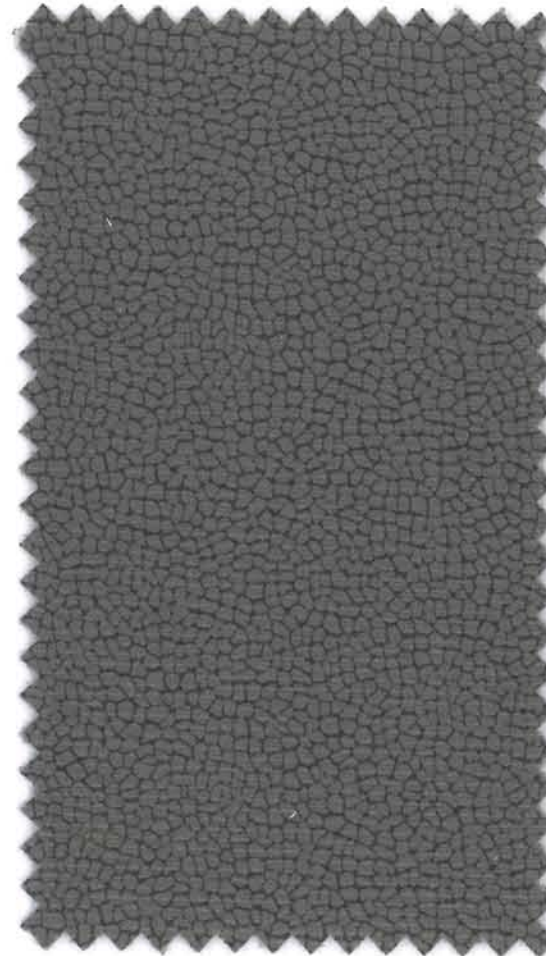

HAMSTER



ANTRACITA

Composición / Composition:

**100% Poliéster**

Peso / Weight: **400 gr/m<sup>2</sup>**

Ancho / Width: **140 cm.**

Resistencia a la abrasión / Abrasion resistance:

**>30.000 ciclos**

Solidez al frote / Rubbing fastness: **4-5**

ISO 105 C06:2010 B2S GRADE

Solidez a la luz / Light fastness: **3-4**

ISO 105 C06:2010 B2S GRADE

Solidez al lavado / Washing fastness: **3-4**

ISO 3759:2011, ISO 6330:212 (5N TUMBLE DRY)

ISO 5077:2007 GRADE

# Serie M

*Blue*



BLANCO



BEIGE



LIMÓN



VERDE PASTEL



AZUL

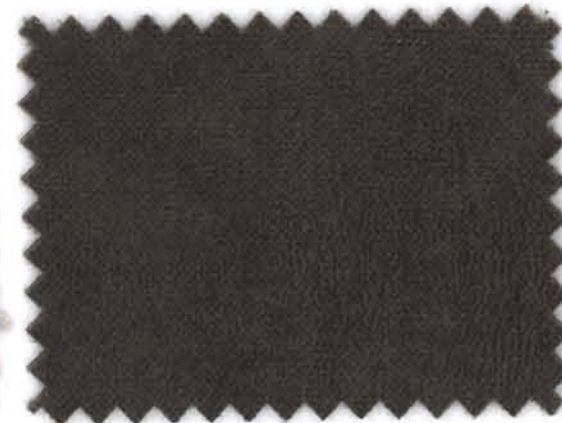

TRUFA

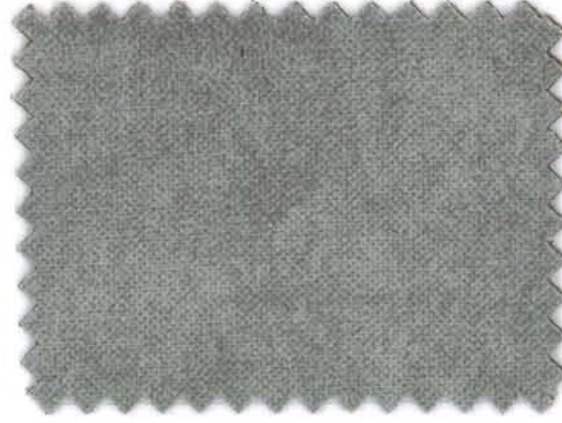

PERLA



CENIZA

Composición / Composition:

**100% Poliéster**

Peso / Weight: **314 gr/m<sup>2</sup>**

Ancho / Width: **140 cm.**

Resistencia a la abrasión / Abrasion resistance:

**>40.000 ciclos**

Solidez al frote / Rubbing fastness: **4-5**

ISO 105 C06:2010 B2S GRADE

Solidez a la luz / Light fastness: **4-5**

ISO 105 C06:2010 B2S GRADE

Solidez al lavado / Washing fastness: **4-5**

ISO 3759:2011, ISO 6330:212 (5N TUMBLE DRY)

ISO 5077:2007 GRADE

# Serie H

*Ares*



BEIGE



SAVANA

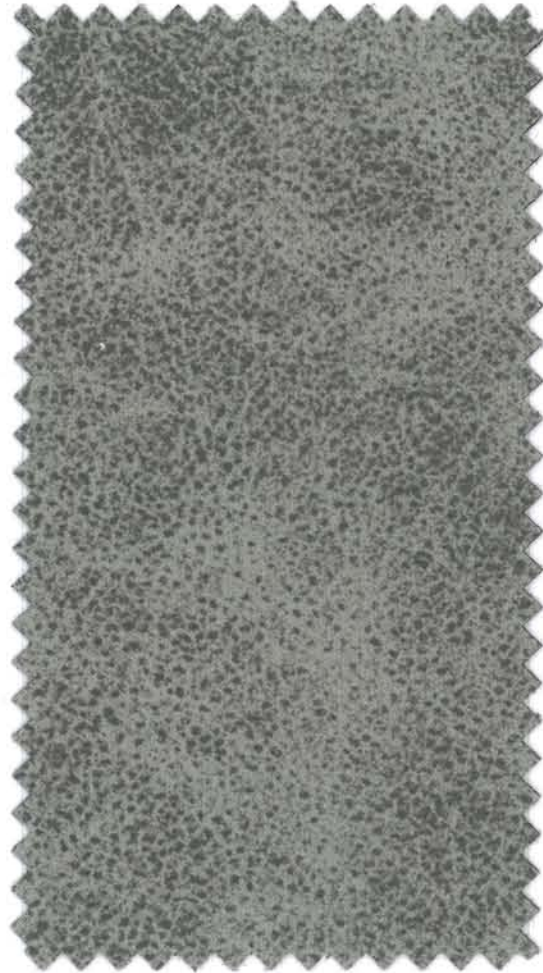

GRIS



CEMENTO

Composición / Composition:

**100% Poliéster**

Peso / Weight: **400 gr/m<sup>2</sup>**

Ancho / Width: **140 cm.**

Resistencia a la abrasión / Abrasion resistance:

**>30.000 ciclos**

Solidez al frote / Rubbing fastness: **4-5**

ISO 105 C06:2010 B2S GRADE

Solidez a la luz / Light fastness: **3-4**

ISO 105 C06:2010 B2S GRADE

Solidez al lavado / Washing fastness: **3-4**

ISO 3759:2011, ISO 6330:212 (5N TUMBLE DRY)

ISO 5077:2007 GRADE

# Serie H

*Tulietta*



TURQUESA



TIERRA



CAFÉ



CHOCO



GRIS



MARENGO

Composición / Composition:

**100% Poliéster**

Peso / Weight: **260 gr/m<sup>2</sup>**

Ancho / Width: **140 cm.**

Resistencia a la abrasión / Abrasion resistance:

**55.000 ciclos**

Solidez al frote / Rubbing fastness: **4**

ISO 105 C06:2010 B2S GRADE

Solidez a la luz / Light fastness: **4**

ISO 105 C06:2010 B2S GRADE

Solidez al lavado / Washing fastness: **4**

ISO 3759:2011, ISO 6330:212 (5N TUMBLE DRY)

ISO 5077:2007 GRADE

# Serie H

*Charlotte*



TIERRA



CHOCO



GRIS



MARENGO

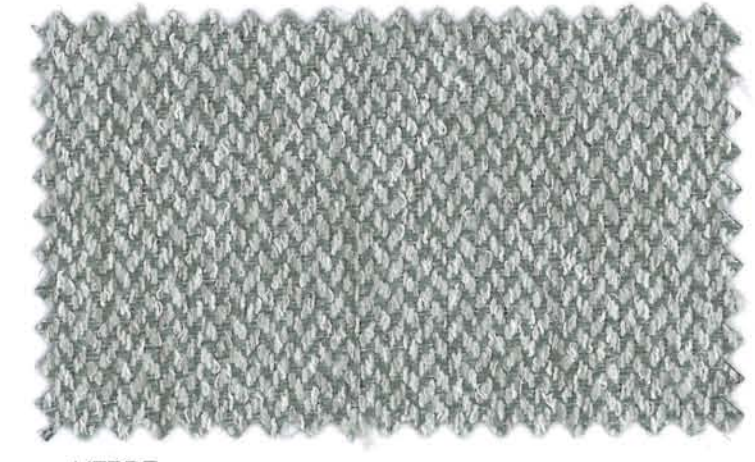

VERDE

Composición / Composition:

**100% Poliéster**

Peso / Weight: **250 gr/m<sup>2</sup>**

Ancho / Width: **140 cm.**

Resistencia a la abrasión / Abrasion resistance:

**>50.000 ciclos**

Solidez al frote / Rubbing fastness: **4-5**

ISO 105 C06:2010 B2S GRADE

Solidez a la luz / Light fastness: **4-5**

ISO 105 C06:2010 B2S GRADE

Solidez al lavado / Washing fastness: **4-5**

ISO 3759:2011, ISO 6330:212 (5N TUMBLE DRY)

ISO 5077:2007 GRADE

# Serie H

*Nido*



BEIGE



CAFÉ



ROSA



CHOCO

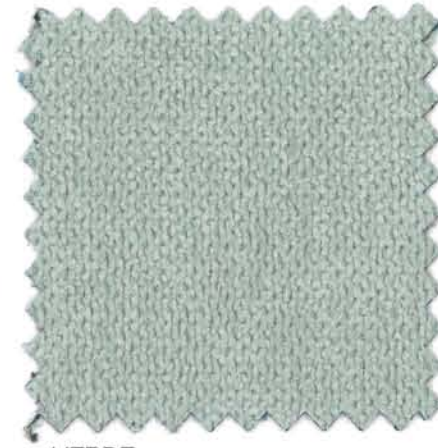

VERDE



TURQUESA

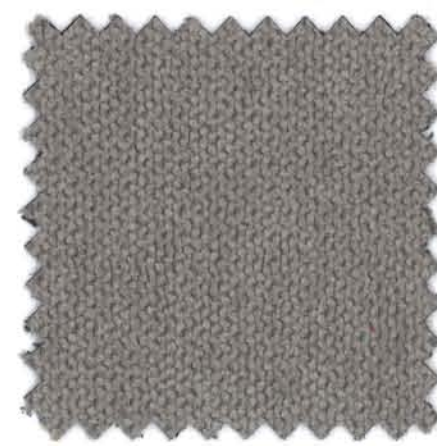

PERLA



MARENGO



AMARILLO

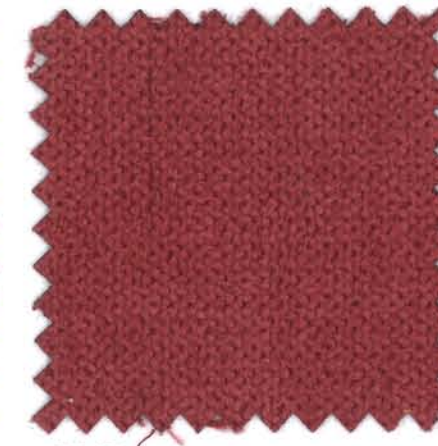

ROJO

Composición / Composition:

**100% Poliéster**

Peso / Weight: **370 gr/m<sup>2</sup>**

Ancho / Width: **140 cm.**

Resistencia a la abrasión / Abrasion resistance:

**>25.000 ciclos**

Solidez al frote / Rubbing fastness: **4-5**

ISO 105 C06:2010 B2S GRADE

Solidez a la luz / Light fastness: **3-4**

ISO 105 C06:2010 B2S GRADE

Solidez al lavado / Washing fastness: **4**

ISO 3759:2011, ISO 6330:212 (5N TUMBLE DRY)

ISO 5077:2007 GRADE



*Tunio*

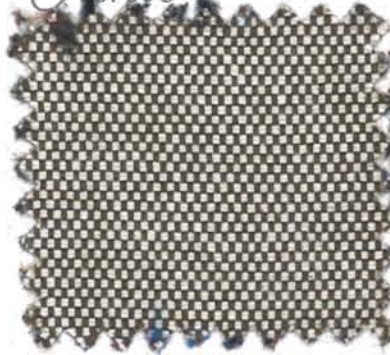

TURRÓN



CHOCO

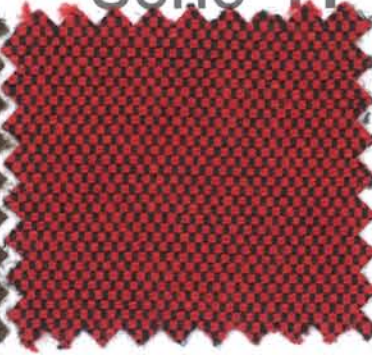

ROJO

**Serie H**

*Lafiro*



NEGRO



CHOCO

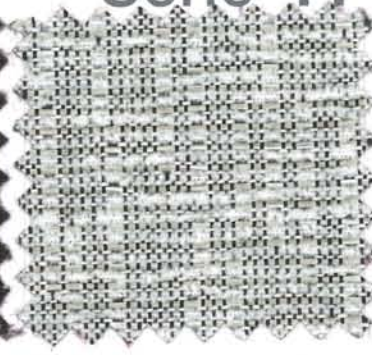

BLANCO

**Serie H**



AZUL

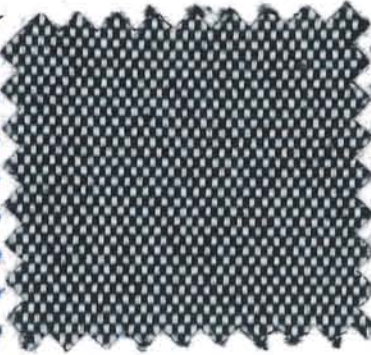

BLANCO



GRIS

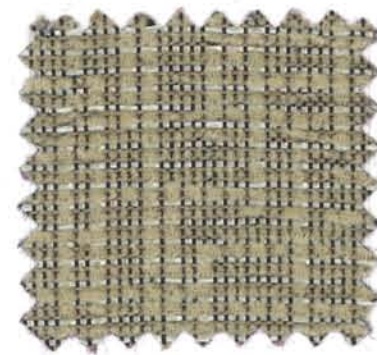

CAMEL



CARDENAL

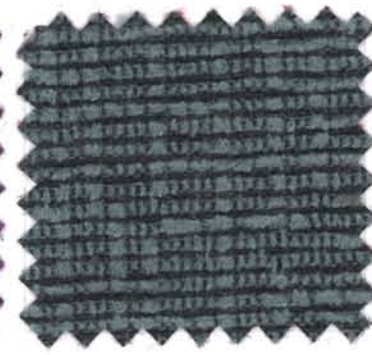

GRIS



NEGRO

Composición / Composition:  
**50% Poliéster 50% Algodón**

Peso / Weight: **281gr/m<sup>2</sup>**

Ancho / Width: **280 cm.**

Composición / Composition:  
**30% Poliéster 25% Algodón  
15% Taslan 30% Acrílico**

Peso / Weight: **212 gr/m<sup>2</sup>**

Ancho / Width: **280 cm.**



ROJO

## Levante

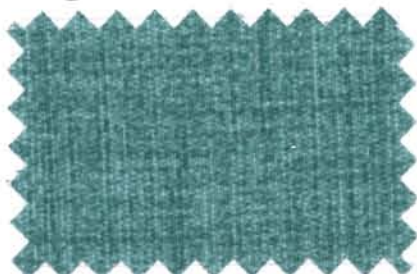

TURQUESA



NARANJA



AZUL



AMARILLO

## Serie A

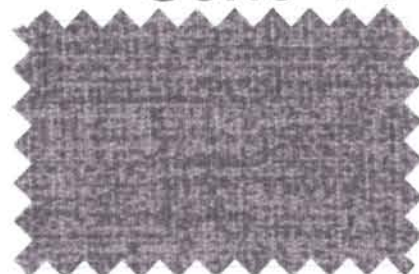

GRIS



CHOCOLATE



BEIGE

Composición / Composition:

**30% Poliéster 70% Algodón**

Peso / Weight: **170 gr/m<sup>2</sup>**

Ancho / Width: **280 cm.**

## Cristal



PERLA

Composición / Composition:

**88% Poliéster 12% PA**

Peso / Weight: **290 gr/m<sup>2</sup>**

Ancho / Width: **280 cm.**

Resistencia a la abrasión /

Abrasion resistance: **>45.000 ciclos**

Solidez al frote / Rubbing fastness: **4-5**

ISO 105 C06:2010 B2S GRADE

## Alba



CHOCO

Composición / Composition: **40% Poliéster 60% Algodón**

Peso / Weight: **198 gr/m<sup>2</sup>**

Ancho / Width: **280 cm.**

## Serie H



CAFÉ

Solidez a la luz / Light fastness: **4-5**

ISO 105 C06:2010 B2S GRADE

Solidez al lavado / Washing fastness: **4**

ISO 3759:2011,

ISO 6330:212 (5N TUMBLE DRY)

ISO 5077:2007 GRADE

## Serie H



NEGRO